

External View (Scale 1:50)

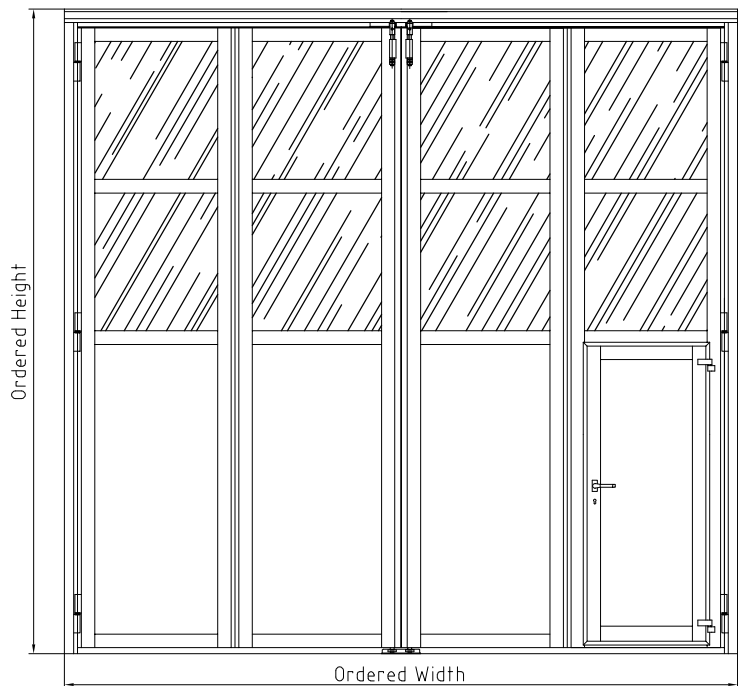

Vertical Cut (Scale 1:50)

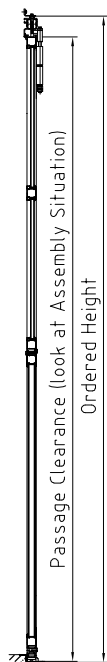

Assembly Situation on the Ledge (Scale 1:10)

a) In front of or behind the reveal IR/BR

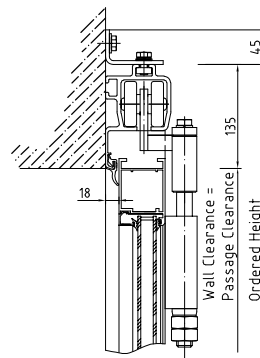

b) In the reveal IR

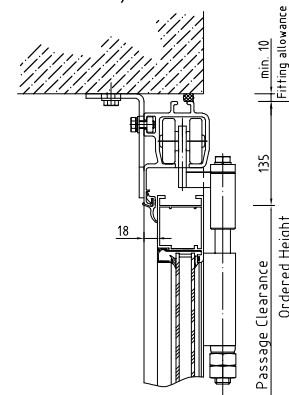

Bottom Details (Scale 1:10)

a) Threshold L50

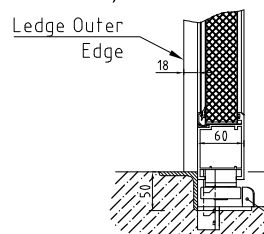

b) Threshold L50D

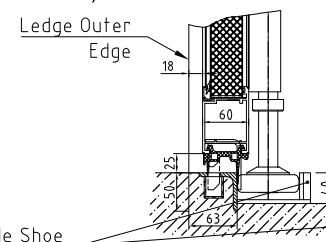

c) Threshold U50D

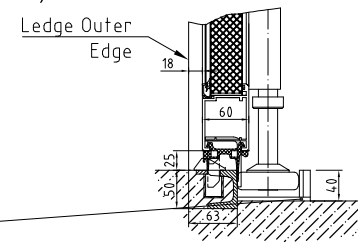

Horizontal Cut (Scale 1:50)

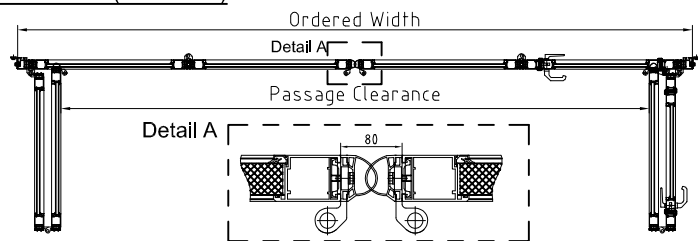

d) Thresholdless Latch Stop RA

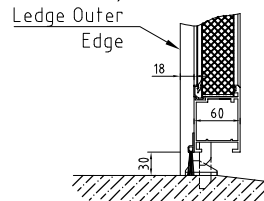

e) Flat Steel Threshold S10D

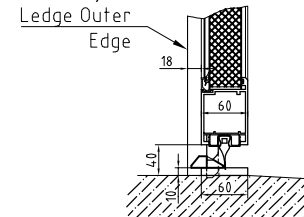

f) Floorguide

g) Floorguide light Niro

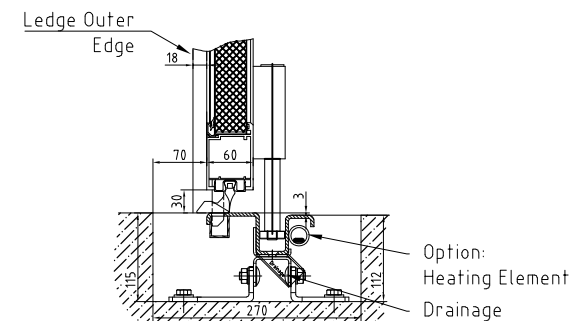
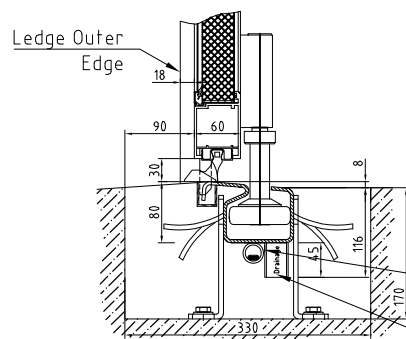

Assembly Situation (Scale 1:10)

a) In front of or behind the reveal IR/BR

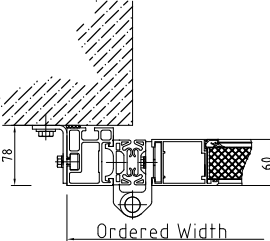

b) In front and through the vertical frame profile

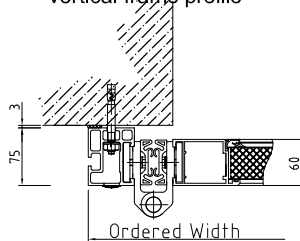

c) In the reveal IR

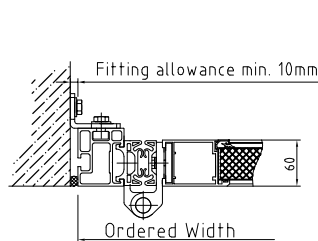

Installation drawing  
AL602F