

External View (Scale1:50)

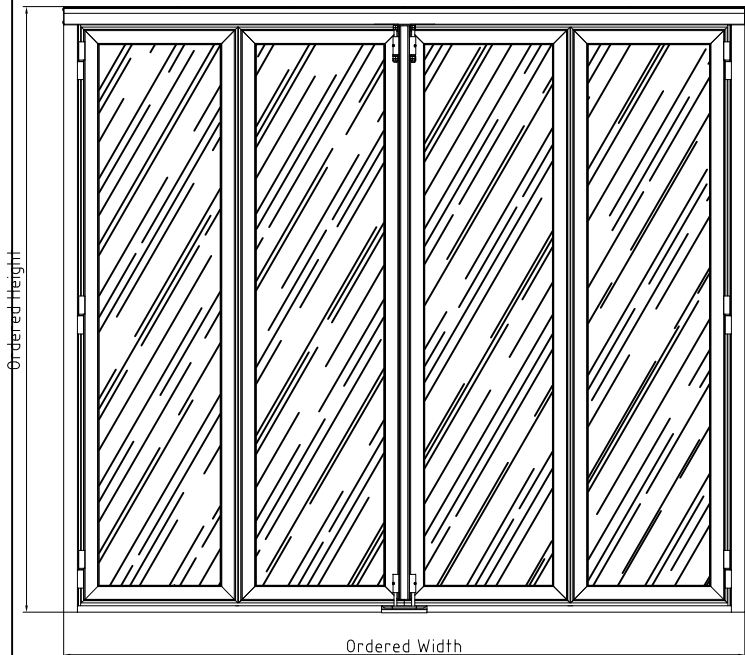

Vertical Cut (Scale1:50)



Assembly Situation on the Ledge (Scale1:10)

a) Infront of or behind the reveal IR/BR

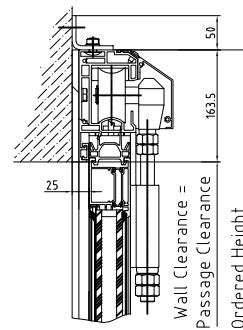

b) In the reveal IR

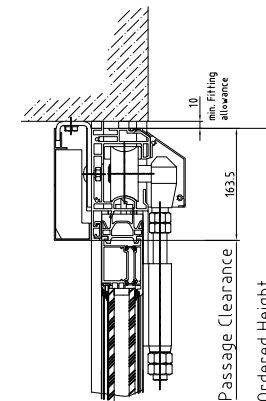

Bottom Details (Scale1:10)

a) Threshold DA

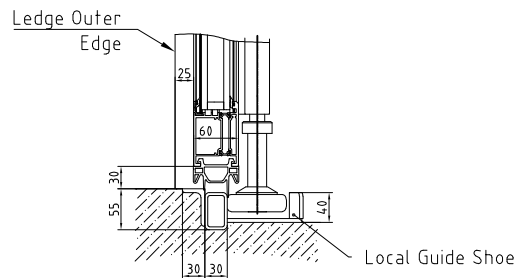

b) Flat steel Threshold S20D

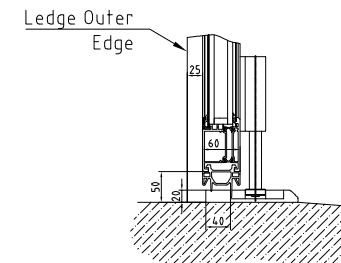

Horizontal Cut (Scale1:50)

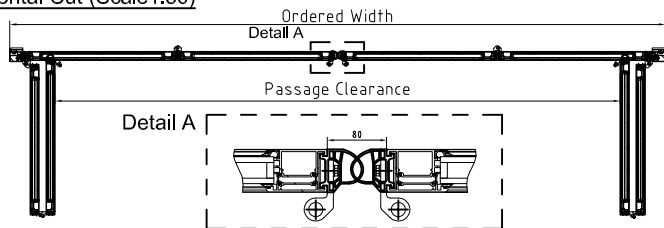

Assembly Situation (Scale1:10)

a) Infront of or behind the reveal IR/BR

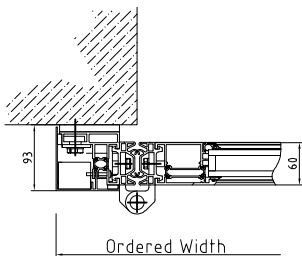

b) In the reveal IR

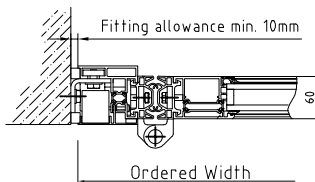

c) Floorguide -light Niro

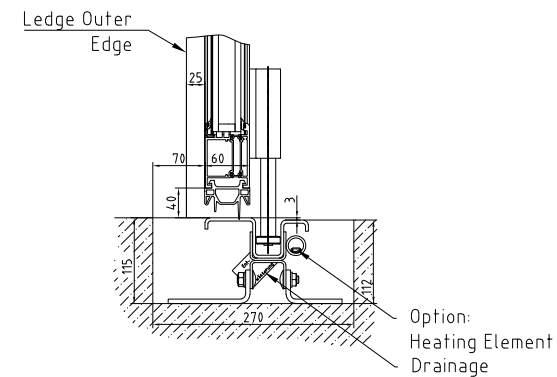

Installation drawing
AL603EEF