



# Installation instructions

Door control

TS 971

Automatic control panel with radio

Version: 51171521



– en –

Status: j / 12.2019



## GfA-Stick, GfA+ App and fault guide

The GfA-Stick is available for setting and servicing works on the door. Together with the GfA+ App, the tool enables reading and display of important data from GfA door controls TS 959, TS 970 and TS 971 via smartphone or tablet PC. This data includes, for example:

- Serial number, software version, cycle counter reading
- Connected hardware (e.g. sensor)
- Current programming
- Display of the last 128 events on the door
- Fault memory with fault guide for remedy

The data can be managed conveniently via the GfA-Portal.  
The GfA-Portal can be reached via the GfA website:

[www.gfa-elektromaten.com](http://www.gfa-elektromaten.com)



Save time when testing, servicing and repairing the door. Use the GfA-Stick and GfA+ App.

Do you also need the fault guide from the App as a PDF document? You can also find this on the GfA website - in the download area.



GfA-Stick Part No.: 20003696

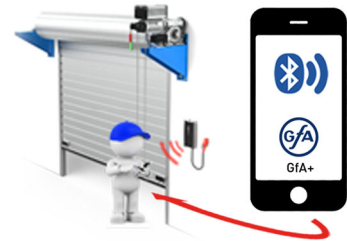

GfA ELEKTROMATEN GmbH & Co. KG  
Wiesenstraße 81 • 40549 Düsseldorf

[www.gfa-elektromaten.de](http://www.gfa-elektromaten.de)  
 [info@gfa-elektromaten.de](mailto:info@gfa-elektromaten.de)

## Contents

<b>1</b>	<b>General safety information</b> .....	<b>6</b>
<b>2</b>	<b>Technical data</b> .....	<b>7</b>
<b>3</b>	<b>Mechanical installation</b> .....	<b>8</b>
<b>4</b>	<b>Electrical installation</b> .....	<b>9</b>
	Connection cable connection overview .....	10
	Limit switch configuration, screwable version up to year of construction in 1997 .....	11
	Limit switch configuration, single limit switches .....	11
	Carrying out the electrical installation .....	12
	Mains supply .....	13
	Mains supply to control .....	13
	Completing the electrical installation .....	13
	Overview of control .....	14
<b>5</b>	<b>Starting up the control</b> .....	<b>15</b>
	DES: Rapid adjustment of final limit positions .....	15
	NES: Rapid adjustment of final limit positions .....	16
<b>6</b>	<b>Electrical installation – control accessories</b> .....	<b>17</b>
	Connection of door safety switches X2 .....	17
	Connection of safety devices X2 .....	18
	External supply X1 .....	19
	Emergency stop X3 .....	19
	Automatic closing, On/Off X4 .....	19
	External control device X5 .....	19
	Photo cell X6 .....	19
	Light curtain X6 .....	20
	Radio receiver X7 .....	20
	Pull switch X7 .....	20
	Intermediate open X8 .....	20
	Red/green traffic lights X20 / X21 .....	20
	Magnetic brake X20 / X21 .....	20
<b>7</b>	<b>Control programming</b> .....	<b>21</b>
<b>8</b>	<b>Table menu items</b> .....	<b>22</b>
	Door operating modes .....	22
	Door positions .....	23

Door functions .....	24
Safety functions.....	29
DI/FI settings .....	30
Extended door functions.....	31
Maintenance cycle counter.....	32
Readout of data memory .....	33
Deleting / readout.....	33
Reading out WSD door-module data.....	34
<b>9 Safety devices.....</b>	<b>35</b>
X2: Input, door safety switch .....	35
X2: Input for safety devices .....	37
Installation of the spiral cable .....	38
EMERGENCY operation .....	41
X3: Input, emergency STOP .....	41
<b>10 Functional description .....</b>	<b>42</b>
X: 24 VDC voltage supply .....	42
X1: Mains supply of the control and supply of external devices .....	42
X4: Input, automatic closing Off/On.....	43
X5: Input, control device.....	43
X6: Input "Through / reflective photo cell" resp. light curtain .....	44
X7: Input pull switch/radio receiver.....	47
Internal radio receiver.....	48
Teach-in of radio transmitter .....	48
Deleting an individual radio transmitter .....	49
Deleting all radio transmitters .....	49
X8: Input, intermediate stop On/Off.....	50
X20 / X21: Potential-free relay contacts .....	51
Force monitoring (DES only) .....	51
Travel time monitoring (NES only).....	52
UBS system .....	53
UBS connection .....	53
Reversing duration adjustment.....	53
Maintenance cycle counter.....	54
Short-circuit/overload display .....	54

Display for active WSD door-module wireless safety device .....	54
Standby function .....	54
Illumination of the built in push button of the door control .....	54
<b>11 Status display .....</b>	<b>55</b>
Faults .....	55
Commands.....	60
Status indications.....	60
<b>12 Explanation of symbols .....</b>	<b>62</b>
<b>13 Declaration of incorporation / Declaration of conformity.....</b>	<b>64</b>

### Symbols



**Warning** - Risk of injury or danger to life!



**Warning** - Danger to life from electrical current!



**Note** - Important information!



**Prompt** - Required action!

Illustrations show example products. Differences from the delivered product are possible.

## 1 General safety information

### Specified use

The door control is intended for a power-operated door with a drive unit (NES/DES GfA limit switch system).

The safe operation is only guaranteed with specified normal use. The drive unit is to be protected from rain, moisture and aggressive ambient conditions. No liability for damage caused by other applications or non-observance of the information in the manual.

Modifications are only permitted with the agreement of the manufacturer. Otherwise the Manufacturer's Declaration shall be rendered null and void.

### Safety information



**Warning ! Failure to follow these installation instructions may result in severe injury or death.**

- Please read these instructions before using the product
- Keep these instructions handy
- Please include these instructions when you pass on the product

Installation and commissioning are to be performed by skilled personnel only.

Only trained electrical craftsmen are permitted to work on electrical equipment. They must assess the tasks assigned to them, recognise potential danger zones and be able to take appropriate safety measures.

Installation work is only to be carried out with the supply off.

Observe the applicable regulations and standards.

### Coverings and protective devices

Only operate with corresponding coverings and protective devices.

Ensure that gaskets are fitted correctly and that cable glands are correctly tightened.

### Spare parts

Only use original spare parts.

## 2 Technical data

Series		TS 971
Dimensions W x H x D		155 mm x 386 mm x 90 mm
Installation		Vertical, free of vibration
Operating frequency		50 Hz / 60 Hz
Supply voltage (+/- 10%)		1 N~220-230 V, PE 3 N~220-400 V, PE 3~220-400 V, PE
Output power for drive unit, maximum		3 kW
Protection per phase, on-site		10 A ..... 16 A
External mains supply: Internal electronic protection		24 V DC 0.35 A
External mains supply: X1/L, X1/N Protection via F1 micro-fuse		1 N~230 V 1.6 A time-lag
Control inputs		24 V DC, type. 10 mA
Relay contacts		2 potential-free changeover contacts
Loading of relay contacts, ohmic/inductive		230 V AC, 1 A 24 V DC, 0,4 A
Control power consumption		18 W
Temperature range	Operation Storage	-10 °C ..... +50 °C +0 °C ..... +50 °C
Air humidity, non-condensing		up to 93 %
Protection class of housing with CEE-plug		IP 54 / IP 65
Protection class of housing		IP 65
Compatible GfA - limit switch		NES (mechanical limit switch) DES (digital limit switch)
Integrated radio receiver	WSD Radio	2.4 GHz 434 MHz

### 3 Mechanical installation



#### Control installation!

- Indoor use only
- Mounting only on even ground that is free of vibration
- Only vertical mounting position allowed
- Door must be in clear view from place of installation

#### Requirements

The permissible loads on walls, mountings, connection and transmission elements must not be exceeded.

#### Mounting

The control is mounted via 4 elongated holes

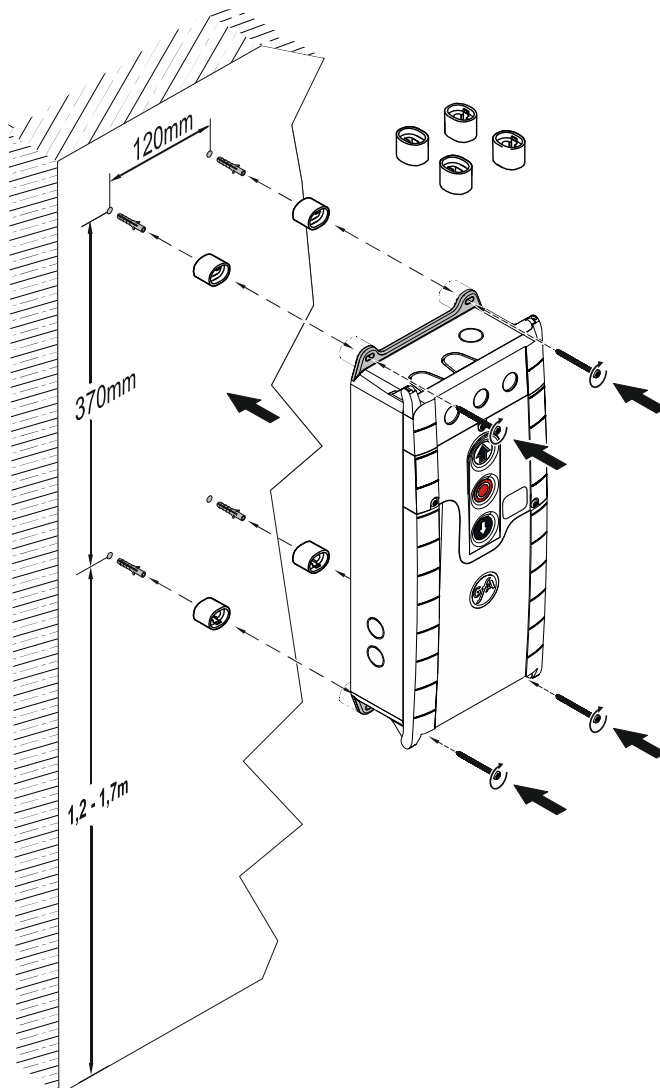



## 4 Electrical installation



### Warning - Danger to life due to electrical current!

- Disconnect the cables (mains OFF) and check that the supply is off
- Observe the applicable regulations and standards
- Ensure proper electrical connection
- Use suitable tools



### On-site backup fuse and mains disconnector!

- Only use all current sensitive earth leakage circuit breakers type B for FI-drive units
- Connection to the indoor installation via an all-pole disconnecter unit, with current  $\geq 10$  A as per EN 12453 (e.g. CEE plug connector, main switch)



### Note! - The inputs of the following safety devices of the control are rated

#### Performance Level c (PLc):

- Slack-rope switch
- Pass-door switch
- Safety edge
- Limit switch system
- Safety circuit of the drive unit
- Emergency STOP control device

Connect only sensors that comply with the current EN 12453 and are suitable for Performance Level c.



Observe the installation instructions of the drive unit!

## Connection cable connection overview

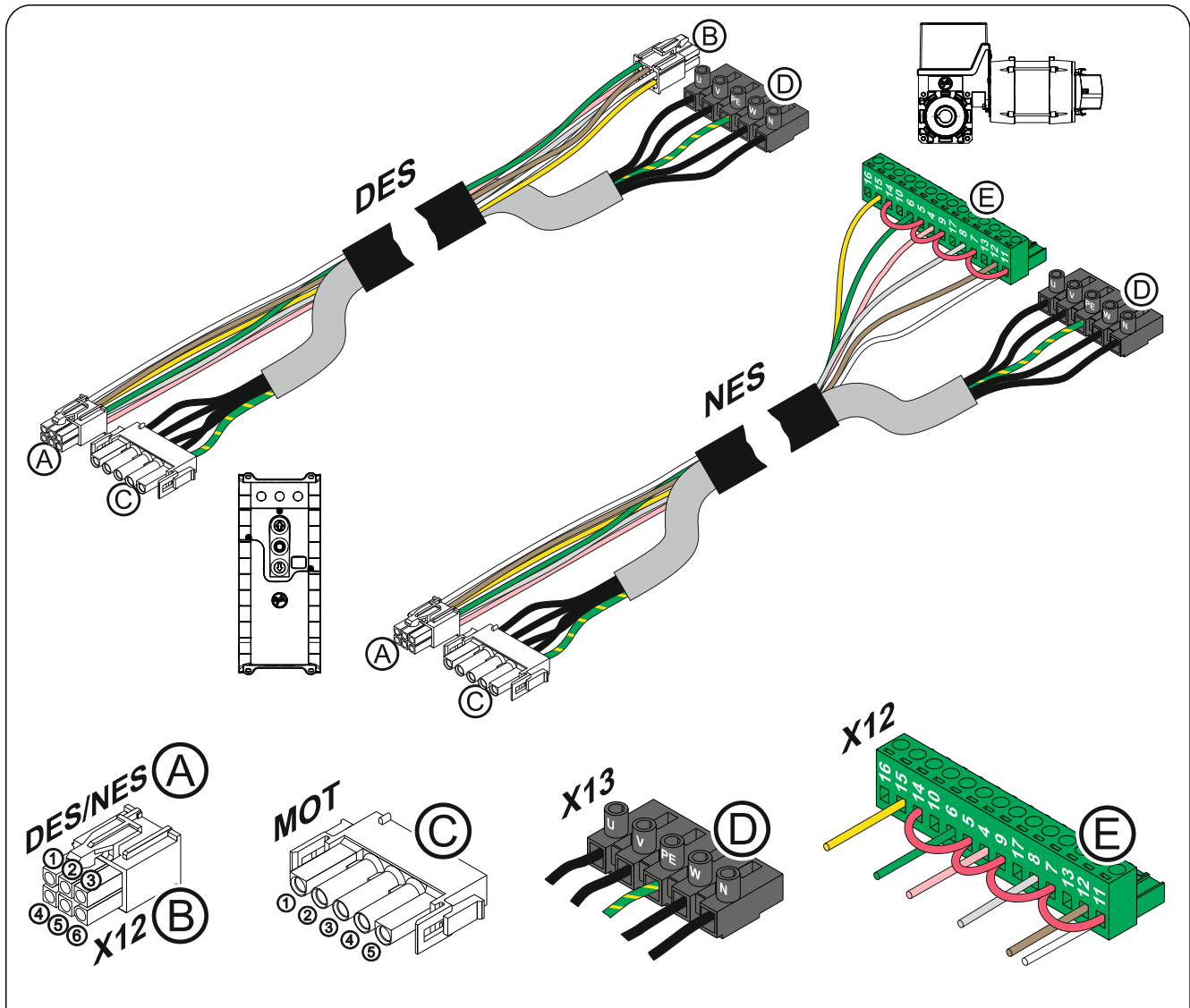

Ⓐ DES → Ⓑ X12 DES				Ⓒ MOT → Ⓓ X13			
Pin	Core	Pin	Description:	Pin	Core	Term.	Description:
①	5/wh	①	+24 V safety circuit	①	3	W	Phase W
②	6/bn	②	Channel B (RS485)	②	2	V	Phase V
③	7/gn	③	Ground	③	1	U	Phase U
④	8/ye	④	Channel A (RS485)	④	4	N	Neutral conductor (N)
⑤	9/gy	⑤	Safety circuit	⑤	PE	PE	
⑥	10/pk	⑥	8 V DC supply voltage				

  

Ⓐ NES → Ⓔ X12 NES			
Pin	Core	Term.	Description:
①	5/wh	11	Limit switch common +24 V, wire link to: 7, 9, 5, 14
②	6/bn	12	S5 Auxiliary limit switch
③	7/gn	6	S3 Open limit switch
④	8/ye	15	S6 Auxiliary limit switch
⑤	9/gy	8	S4 CLOSE limit switch
⑥	10/pk	4	Safety circuit

## Limit switch configuration, screwable version up to year of construction in 1997

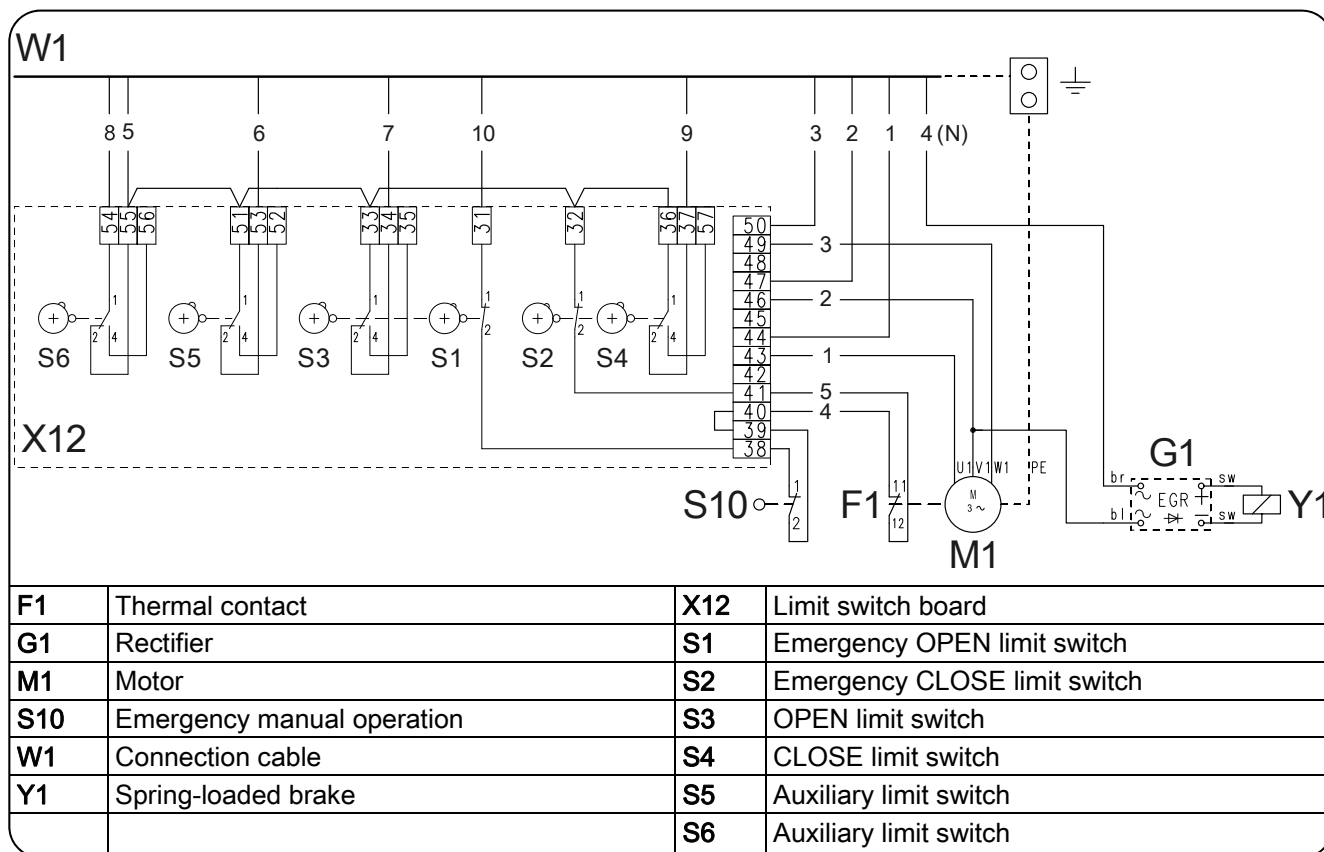

## Limit switch configuration, single limit switches

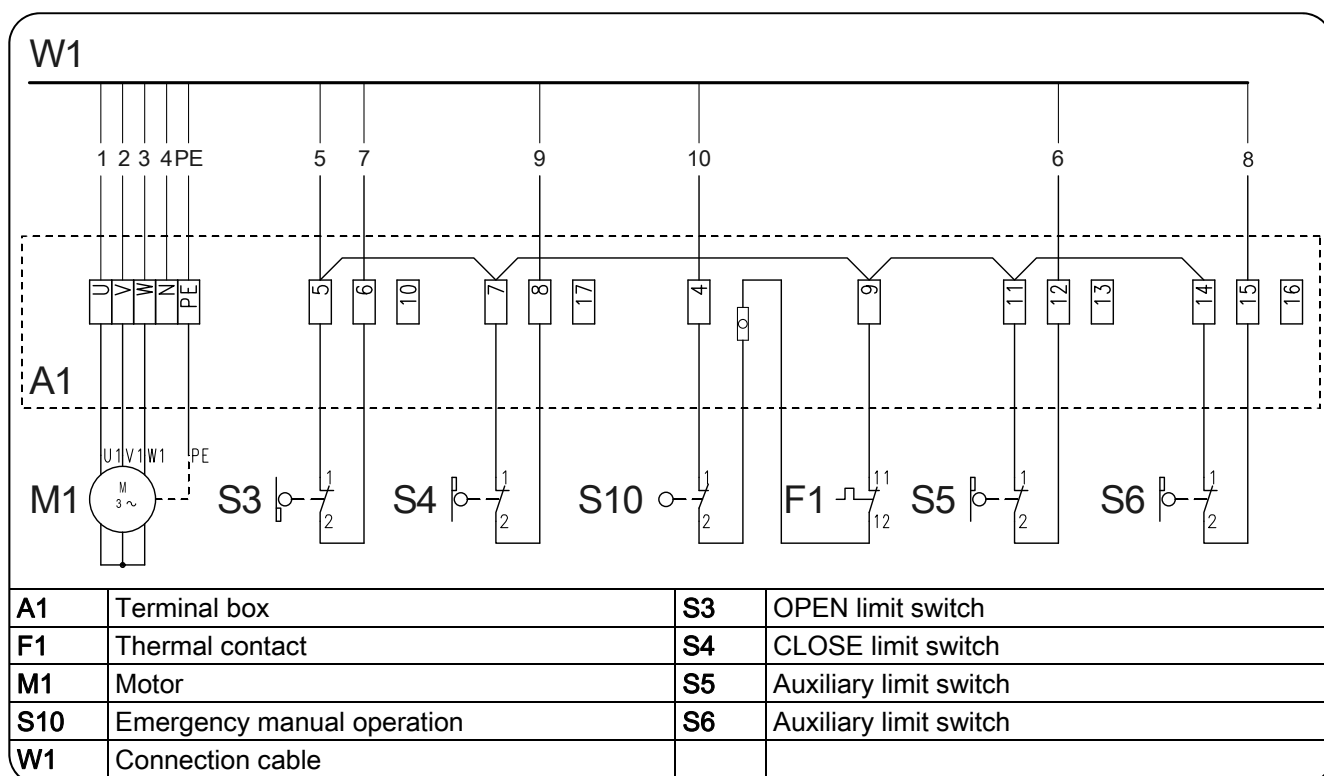

## Carrying out the electrical installation

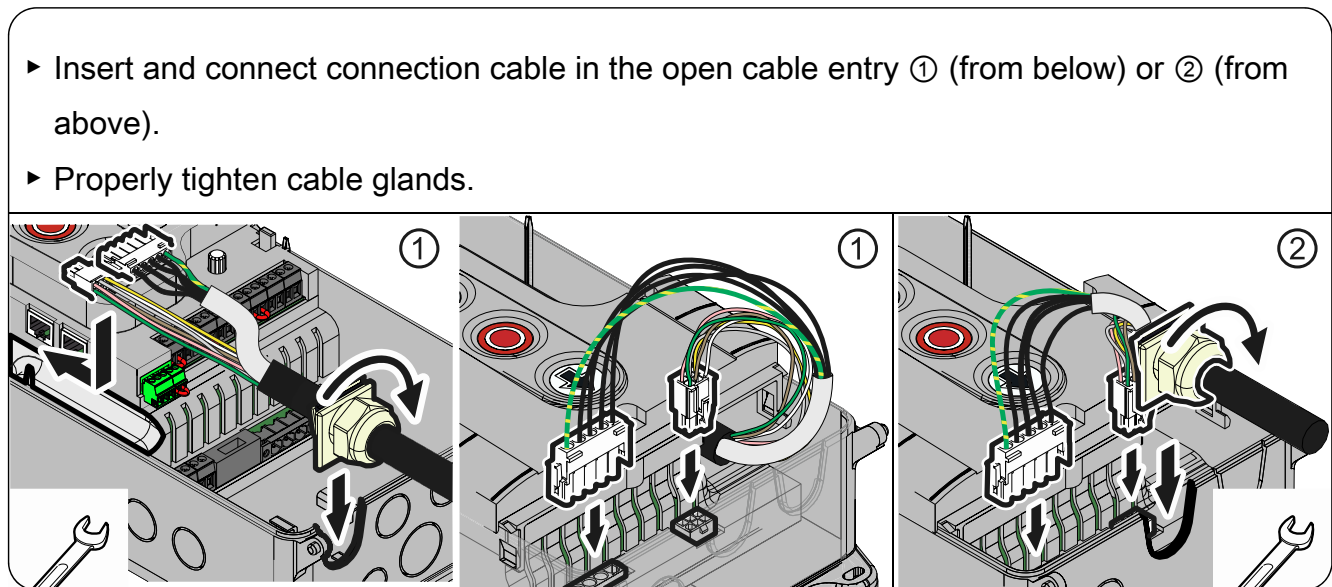
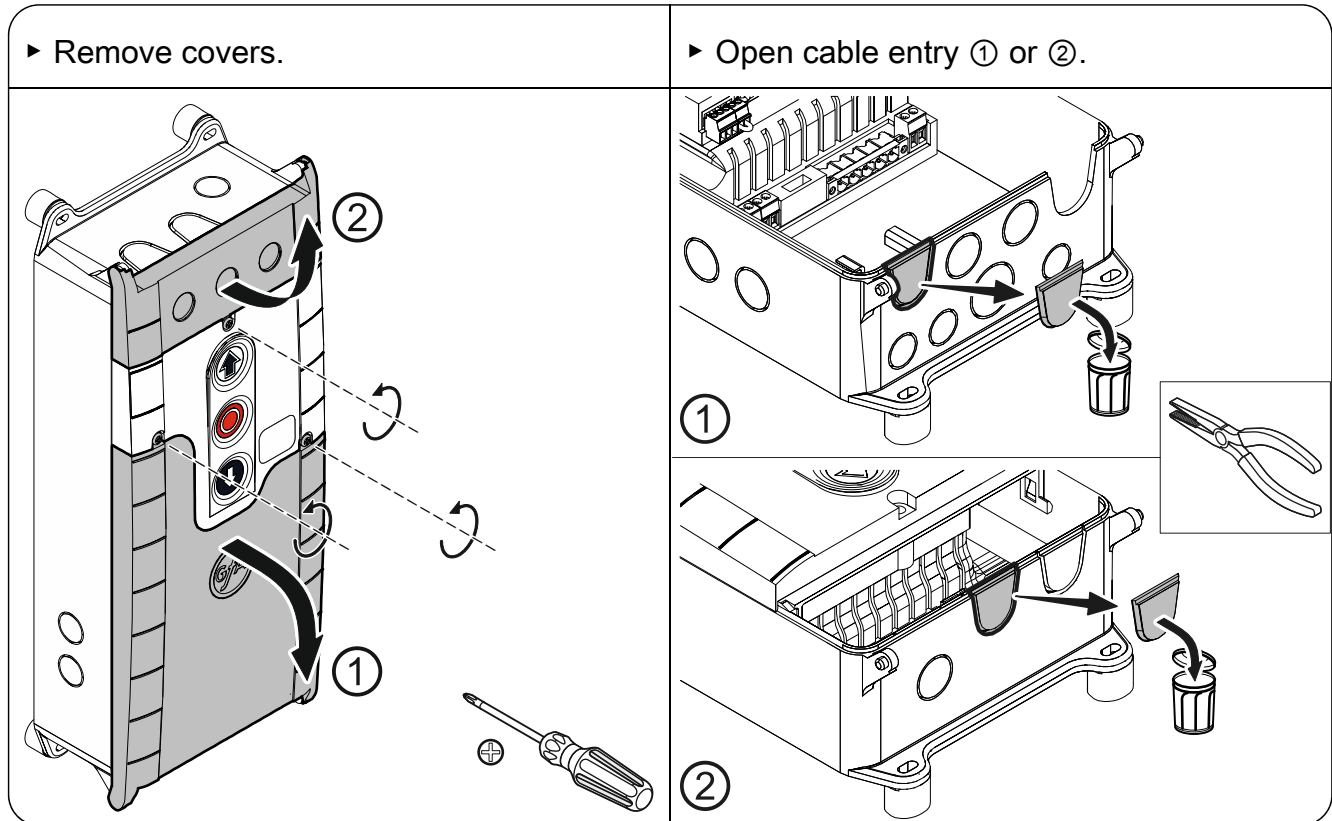

**Avoid damage to parts!**

- Open cable entry with suitable tool

## Mains supply

3~, N, PE 220 – 400 V 50 - 60 Hz	3~, PE 220 – 400 V 50 - 60 Hz	1~, N, PE, sym. 220 – 230 V 50 - 60 Hz	1~, N, PE, asym. 220 – 230 V 50 - 60 Hz

## Mains supply to control

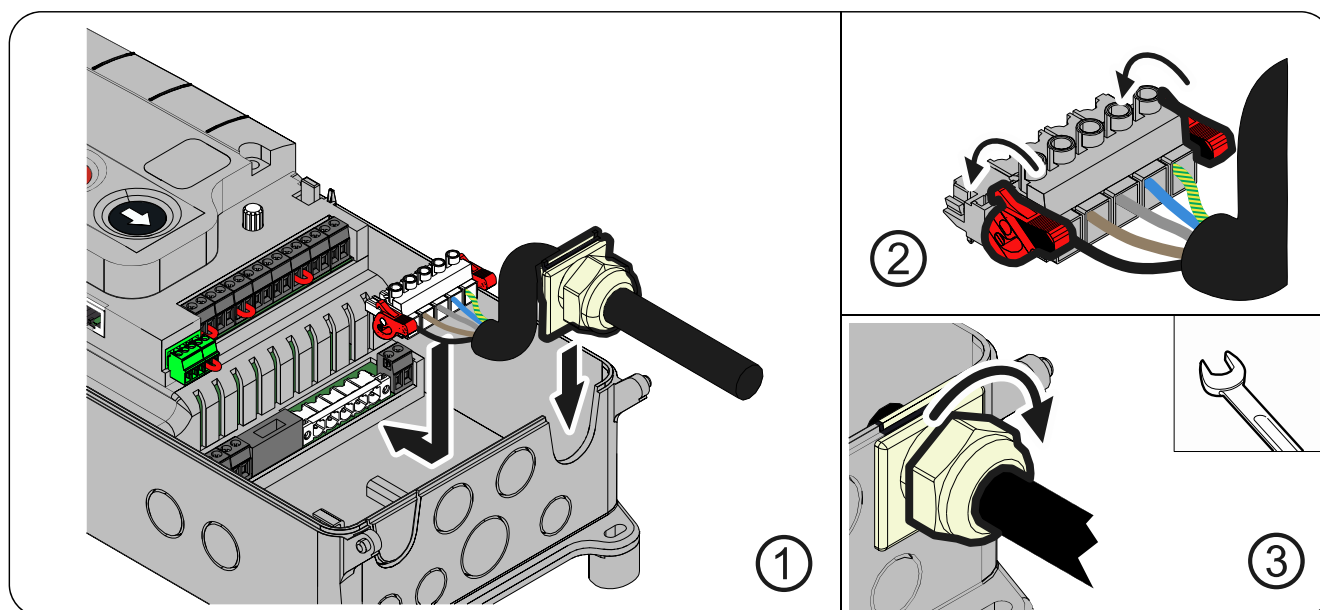

## Completing the electrical installation

Install and tighten cable entries and/or cable glands.

For commissioning of the control, leave the covers open.

## Overview of control

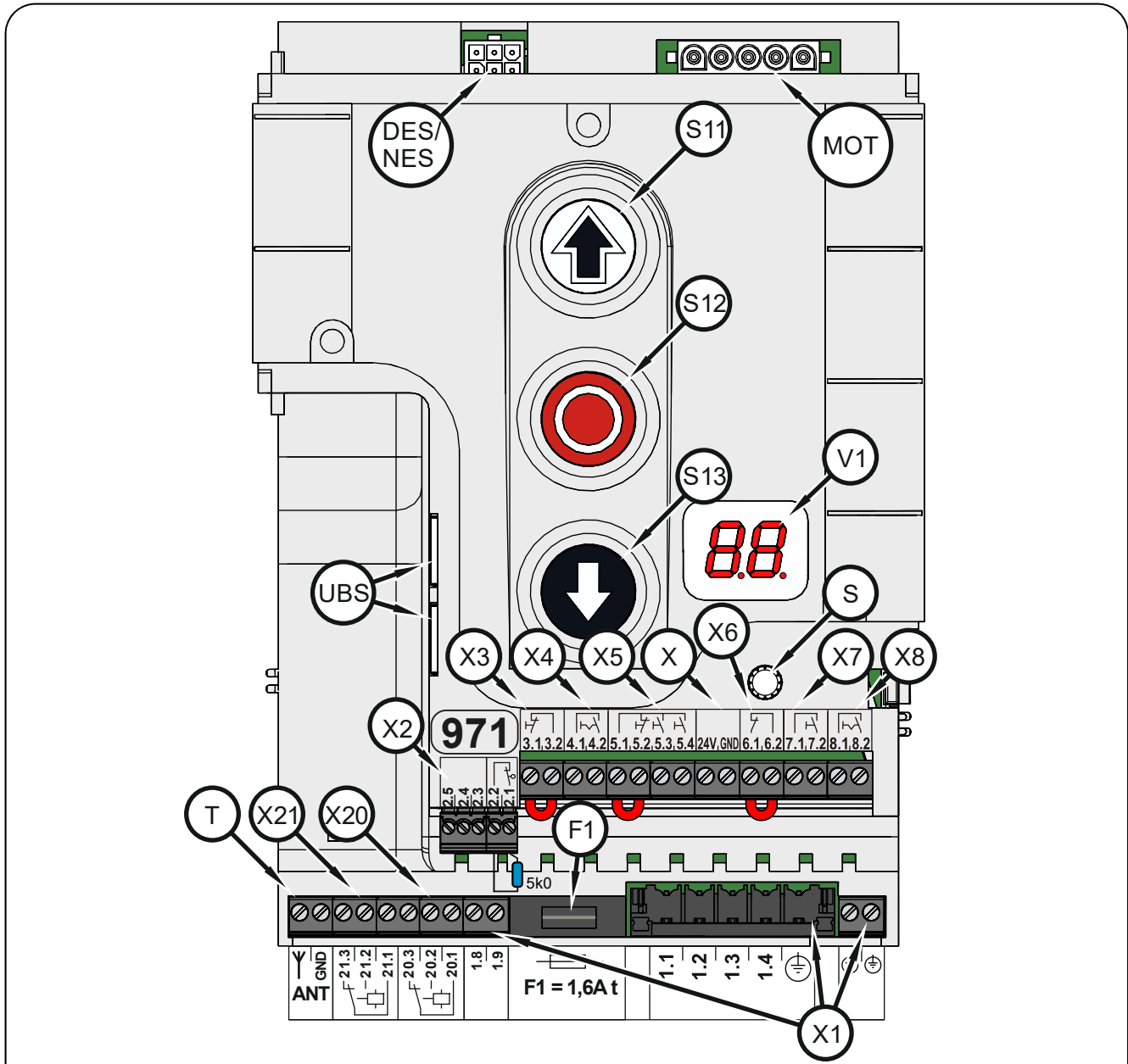

<b>DES/ NES</b>	DES or NES limit switch socket	<b>X</b>	24 V mains supply, external devices
<b>MOT</b>	Motor socket	<b>X1</b>	Mains supply
<b>S</b>	Selector switch	<b>X2</b>	Door safety switch and safety devices
<b>S11</b>	OPEN push-button	<b>X3</b>	Emergency STOP control device
<b>S12</b>	STOP push-button	<b>X4</b>	Automatic closing On/Off
<b>S13</b>	CLOSE push-button	<b>X5</b>	Control device, external three push-button
<b>T</b>	Internal aerial, 434 MHz	<b>X6</b>	Through / reflective photo cell
<b>UBS</b>	Universal command sensor socket	<b>X7</b>	Pull switch, external radio receiver
<b>V1</b>	Display	<b>X8</b>	Intermediate open On/Off
		<b>X20</b>	Potential-free relay contact 1
		<b>X21</b>	Potential-free relay contact 2

## 5 Starting up the control

- Supply cables  
Insert / switch on

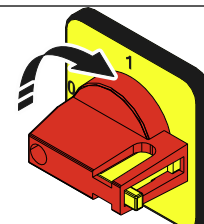
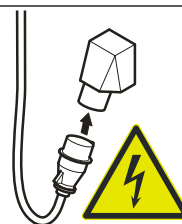

### DES: Rapid adjustment of final limit positions

When using a light curtain with OSE signal output (connection to terminal X2), please note menu item 0.3 first.

#### 1. Check output rotating direction

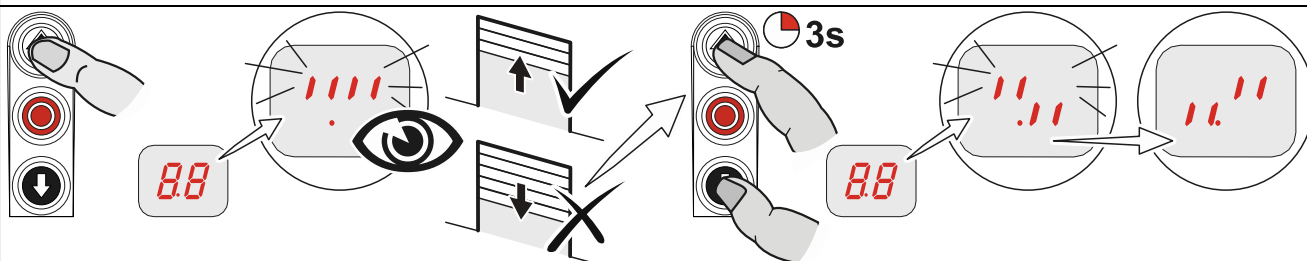

#### 2. Move to OPEN final limit position

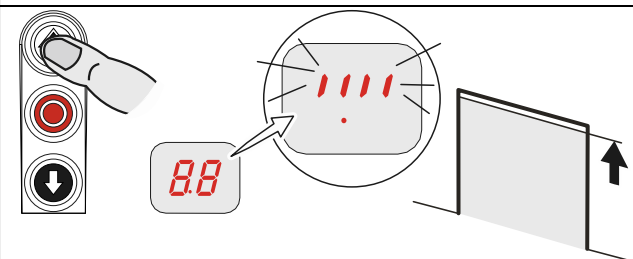

#### 3. Save OPEN final limit position

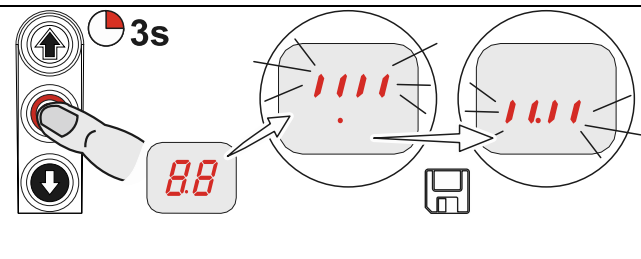

#### 4. Move to CLOSE final limit position

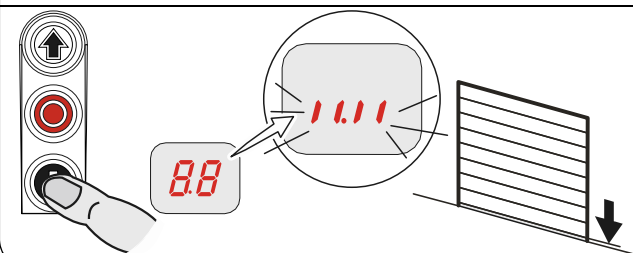

#### 5. Save CLOSE final limit position

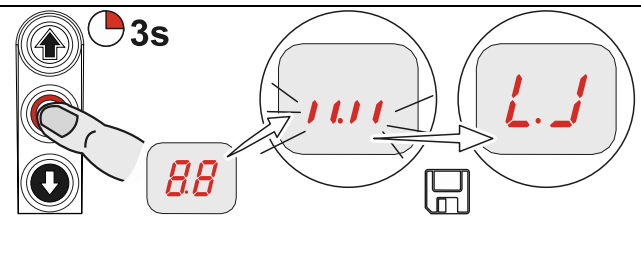

After rapid adjustment of the final limit positions, the door operating mode “Hold-to-run” is active. The final limit positions can be corrected later with menu items 1.1 to 1.4. The pre-limit is set automatically with safety edge connected. A correction is possible using menu item 1.5.





**Observe the installation instructions of the drive unit!**

- For adjusting the mechanical limit switch, see the drive unit installation instructions

## NES: Rapid adjustment of final limit positions

When using a light curtain with OSE signal output (connection to terminal X2), please note menu item 0.3 first.

### 1. Check output rotating direction

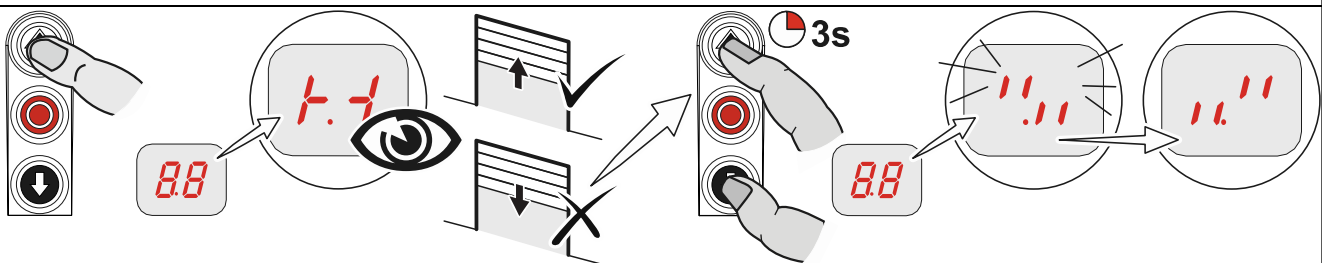

### 2. Move to OPEN final limit position and adjust S3 OPEN limit switch

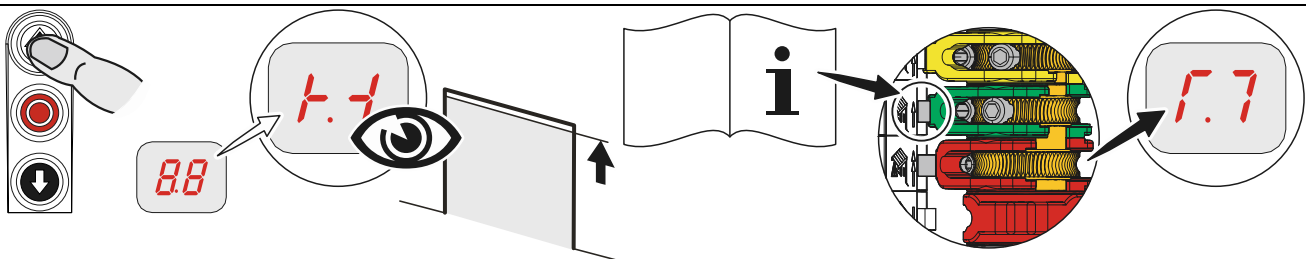

### 3. Move to CLOSE final limit position 5cm above the ground and adjust S5 pre-limit switch

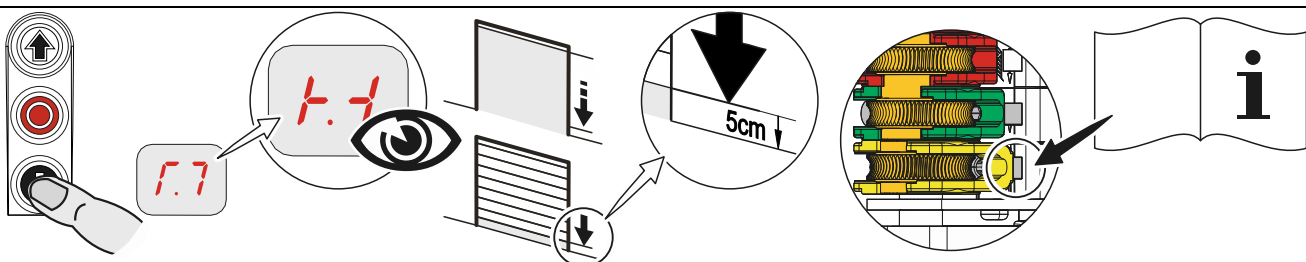

### 4. Move to CLOSE final limit position and adjust S4 CLOSE limit switch

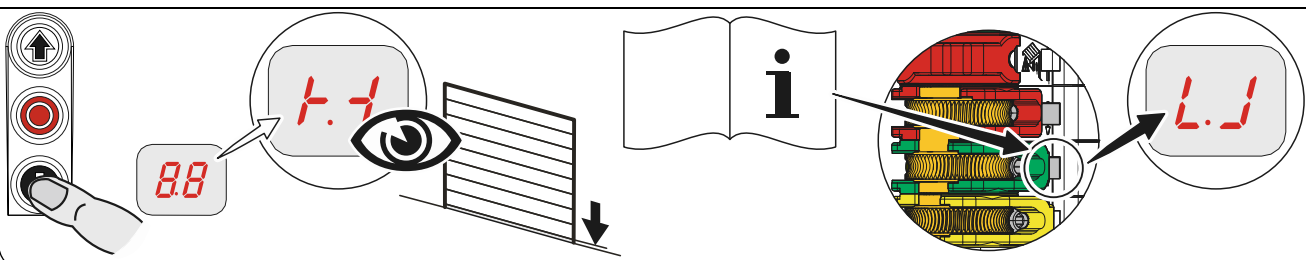



## 6 Electrical installation – control accessories

### Connection of door safety switches X2

Pass-door switch / slack-rope switch  
suitable for Performance Level c (PLc)

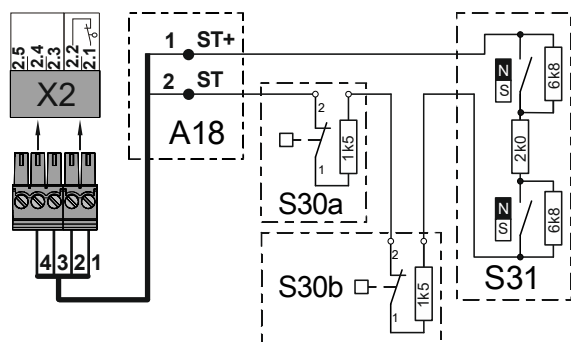

- A18** Junction box
- ST+** Mains supply
- ST** Input for door safety switch
- S30a** Pass-door switch
- S30b** (NC contact)
- S31** Electronic pass-door switch (Entrysense)

### Crash switch as NC contact

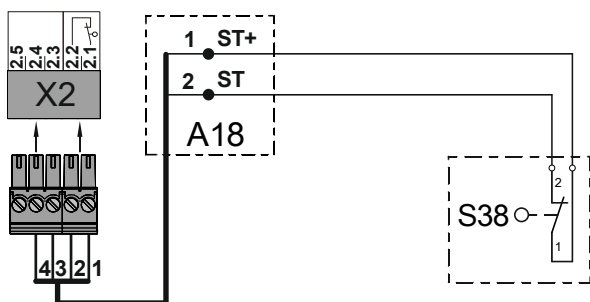

- A18** Junction box
- ST+** Mains supply
- ST** Input for door safety switch
- S38** Crash switch (NC contact)

### Crash switch as NO contact

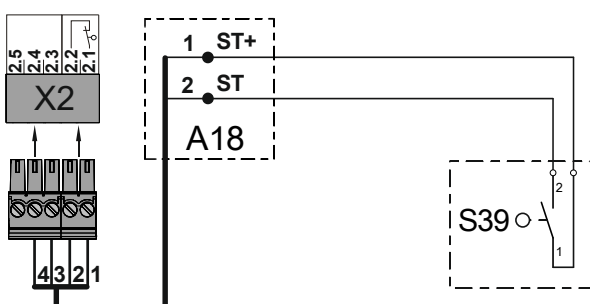

- A18** Junction box
- ST+** Mains supply
- ST** Input for door safety switch
- S39** Crash switch (NO contact)

## Connection of safety devices X2

### Electrical safety edge

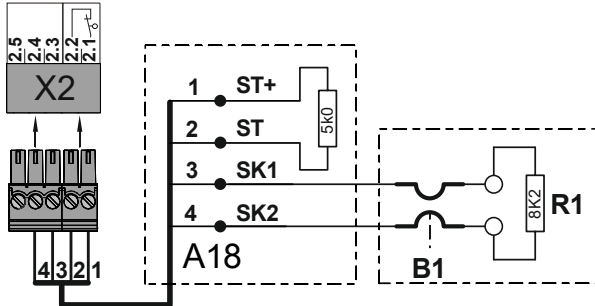

- A18** Junction box
- ST+** Mains supply
- ST** Input for door safety switch
- SK1** Input electrical safety edge
- SK2** Input electrical safety edge
- B1** Electrical safety edge
- R1** End of line resistor (8k2)
- X2** Door control socket

### Pneumatic safety edge

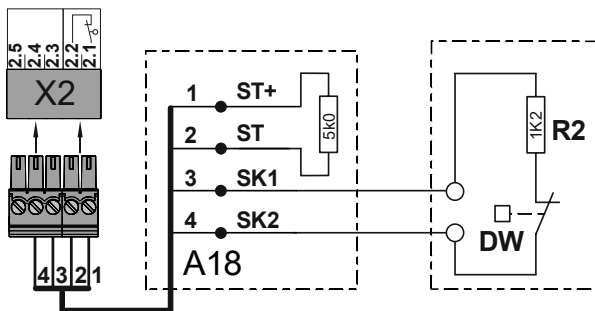

- A18** Junction box
- ST+** Mains supply
- ST** Input for door safety switch
- SK1** Input pneumatic safety edge
- SK2** Input pneumatic safety edge
- DW** Pneumatic switch
- R2** End of line resistor (1k2)
- X2** Door control socket

### Optical safety edge system

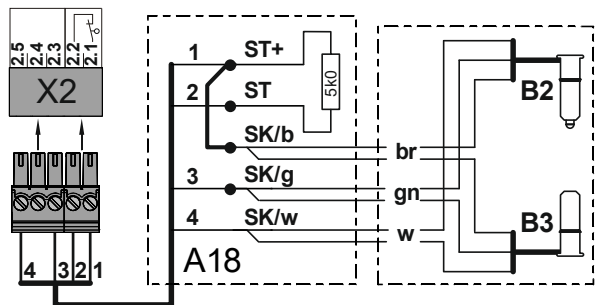

- A18** Junction box
- ST+** Mains supply
- ST** Input for door safety switch
- SK/b** Mains supply (brown)
- SK/g** Output (green)
- SK/w** Earth (white)
- B2** Optical transmitter
- B3** Optical receiver
- X2** Door control socket

### Light curtain (only with OSE interface)

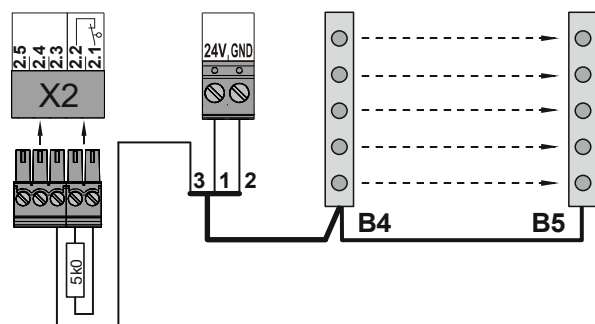

- 1** Mains supply + 24 V
- 2** Ground (GND)
- 3** Signal output light curtain
- B4** Light curtain transmitter
- B5** Light curtain receiver

External supply X1		Emergency STOP X3		Automatic closing, On/Off X4	
<b>A1</b>	External device	<b>A2</b>	Control device Emergency STOP	<b>A3</b>	Control device Key switch
<b>F1</b>	Micro-fuse 1,6 A				

External control device X5					
Three push button		<b>A4</b>	Key push-button	<b>A6</b> Three push button	

Photo cell X6					
<b>A8</b>	Reflective photo cell	<b>A9</b>	Through-beam photo cell Transmitter	<b>A11</b>	Through-beam photo cell Transmitter
		<b>A10</b>	Receiver	<b>A12</b>	Receiver

### Light curtain X6 (only with relay or semiconductor output)

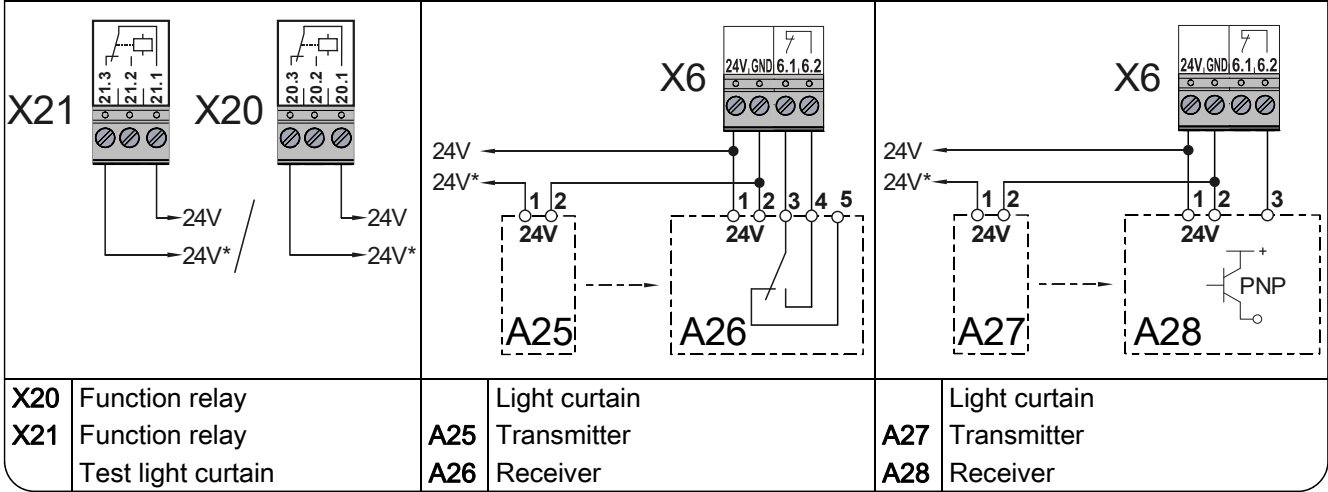

### Radio receiver X7

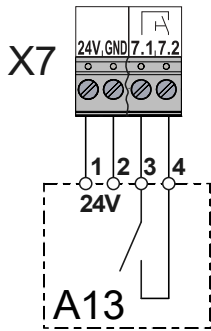

### Pull switch X7

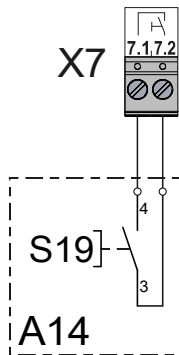

### Intermediate open X8

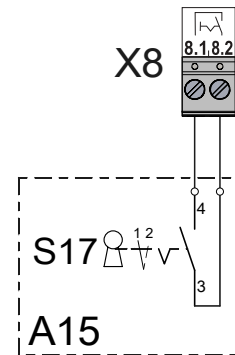

### Red/green traffic lights X20 / X21

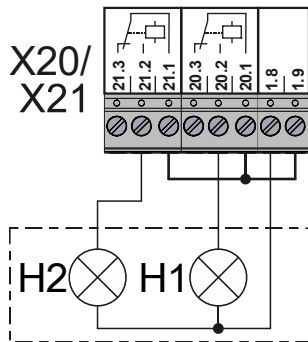

**H1** Traffic light, green  
**H2** Traffic light, red

### Magnetic brake X20 / X21

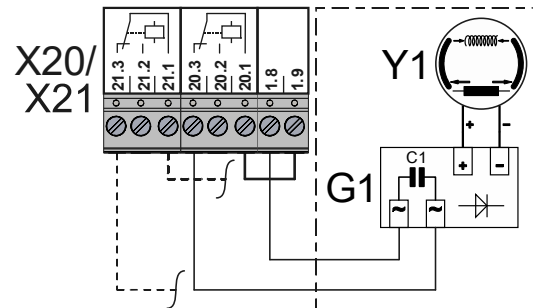

**G1** Rectifier  
**Y1** Magnetic brake



#### Note!

- Install and tighten cable entries and/or cable glands

## 7 Control programming

### 1. Start programming

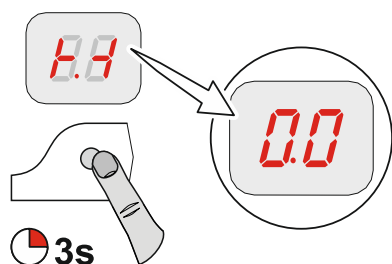

**!** Note!

- Complete programming is only possible after setting the final limit positions

### 2. Select menu item and confirm

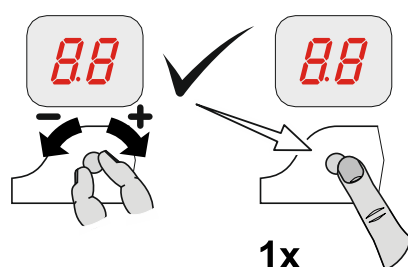

### 3.a) Set and store functions

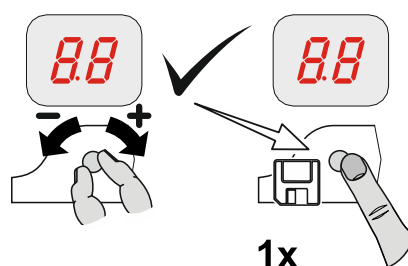



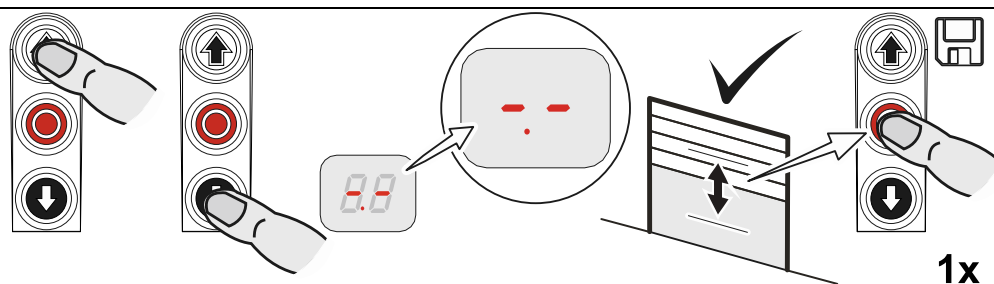



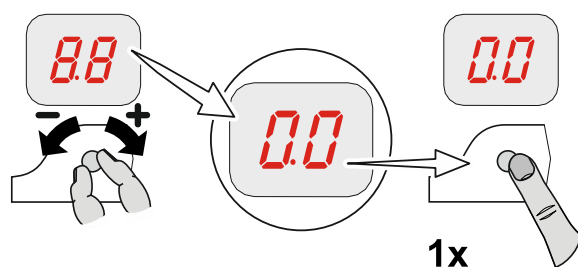



















### 3.b) Set and store positions (DES)



### 4. Exit programming



## 8 Table menu items

Door operating modes			
		<b>Door operating mode</b>	
		Hold-to-run OPEN Hold-to-run CLOSE	 
		Self-hold OPEN Hold-to-run CLOSE	
		Self-hold OPEN Self-hold CLOSE	
		Self-hold OPEN / CLOSE Self-hold, CLOSE hold-to-run release via external X5 control device	
		Hold-to-run OPEN Hold-to-run CLOSE with active safety edge / photo cell	
		<b>Output rotating direction</b>	
		Maintain output rotating direction	
		Change output rotating direction	
		<b>Special function (DES)*</b>	
		Spiral cable or WSD	 
		Light curtain	
		Parallel operation of light curtain and WSD (Operation of a safety edge on WSD not possible)	

**\*) NOTE!**

This menu item is only enabled at initial operation or after a complete reset. The selection must be made before setting the final limit positions. The selection is retained even after a reset but can then be changed.

Door positions					
		<b>OPEN final limit position, coarse correction (DES)</b>			
			Approach and store desired door position		
		<b>CLOSE final limit position, coarse correction (DES)</b>			
			Approach and store desired door position		
		<b>OPEN final limit position, fine correction (DES)</b>			
				Without door movement, [+] OPEN correction [-] CLOSE correction	
		<b>CLOSE final limit position, fine correction (DES)</b>			
				Without door movement, [+] OPEN correction [-] CLOSE correction	
		<b>Fine-correction pre-limit switch for safety edge (DES)</b>			
				Without door movement, [+] OPEN correction [-] CLOSE correction	
		<b>Adjust intermediate open X8 (DES)*</b>			
			Approach and store desired door position		
		<b>Setting for position of relay 1 switching point (DES)*</b> Select relay function via menu item 2.7			
			Approach and store desired door position		
		<b>Setting for position of relay 2 switching point (DES)*</b> Select relay function via menu item 2.8			
			Approach and store desired door position		

\*) Menu items 1.6 to 1.7 disappear at NES. The switching point must be adjusted via the S6 auxiliary limit switch at the drive unit.

## Door functions

	 1x	<b>Safety device</b>	
		<b>Spiral cable</b>	 1x
			 1x
		Select radio channel from .2 to 4.0  Wireless safety device - WSD door-module <b>Wireless safety device</b> for the safety edge (replaces spiral cable). <ul style="list-style-type: none"> <li>Up to 39 doors: Do not assign any radio channel twice.</li> <li>If more than 39 doors: Ensure maximum distance between the door controls with the same channels.</li> <li>Note taught-in channels in the controls housing. Important for service work.</li> </ul>	
		 Pay attention to the WSD door-module manual	

Teach-in of the selected radio channel at the WSD door-module

WSD door-module connected, dot on right is lit

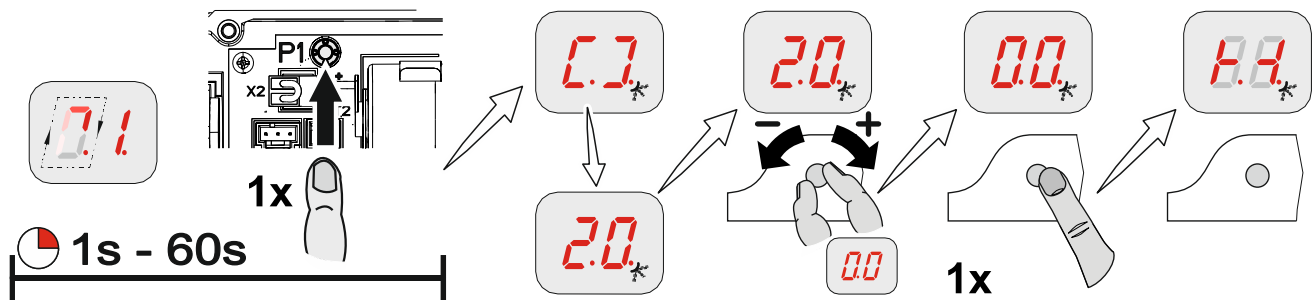



### Door functions

2.1		1x		Safety edge function in the pre-limit area			
	.1	Safety edge active					
	.2	Safety edge inactive					
	.3	Ground adjustment (DES) (Activation of safety edge at ground contact)					
	.4	Reversing in overrun area (DES)					
2.2		1x		Overrun correction (DES)			
	.0	Off					
	.1	On (Do not use with ground adjustment)					

## Door functions









 2.3 1x	<b>Automatic closing</b>			 .0	
 - + - +	 .0	Off		 1x	
	 .1	 99	1 to 99 seconds		
	 1-	 00	 99	100 to 199 seconds	
	 2-	 00	 40	200 to 240 seconds	
 2.4 1x	<b>Reaction of automatic closing to photo cell / light curtain</b>				
 - + - +	 .0	Off		 1x	
	 .1	Stopping of automatic closing and CLOSE command			
	 .2	Vessel recognition Stopping of automatic closing and CLOSE command when actuated for >1.5 seconds			
 2.5 1x	<b>Reverse in case of obstacle</b> (no function with light curtain)			 .2	
 - + - +	 .0	Off		 1x	
	 .1	 10	Adjustable from 1 to 10 Number of safety device actuations		
 2.6 1x	<b>Pull switch or radio receiver function X7</b>				
 - + - +	 .1	Type of impuls 1 Door is in OPEN final limit position      CLOSE command Door is not at OPEN final limit position    OPEN command		 1x	
	 .2	Type of impuls 2 Command sequence OPEN – STOP – CLOSE – STOP – OPEN			
	 .3	Type of impuls 3 OPEN command only			

### Door functions

2.7		Relay function on X20			
2.8		1x Relay function on X21		X20	X21
	.0	Off		1x	
	.1	Impuls contact* for 1 second			
	.2	Permanent contact*			
	.3	Red lamp, permanently lit during door movement OPEN final limit position      Flashing for 3 seconds CLOSE final limit position      Flashing for 3 seconds			
	.4	Red lamp, permanently lit during door movement OPEN final limit position      Flashing for 3 seconds CLOSE final limit position      Off			
	.5	Red lamp, permanently lit during door movement OPEN final limit position      Permanently lit for 3 seconds CLOSE final limit position      Permanently lit for 3 seconds			
	.6	Red lamp, permanently lit during door movement OPEN final limit position      Permanently lit for 3 seconds CLOSE final limit position      Off			
	.7	Permanent green light Dock leveller release Active only in OPEN final limit position			
	.8	Permanent contact in CLOSE final limit position			
	.10	Light sensing device 1-second pulse at each OPEN command			
	.11	Permanent contact at door position*			
	.12	Brake control Active during operation Inactive at stop			
	.14	Light curtain test, etc. Test prior to each closing operation			

\*) Previous teach-in of door positions via menu item 1.7 (1.8) relay X20 (X21) (only DES) or respectively via the S6 auxiliary limit switch of the drive unit (NES).

## Door functions

	 1x	<b>Intermediate open function</b>	
		All command inputs	 1x 
	Input X7.2 and internal radio receiver		
	Input X5.3 and OPEN push-button of control		

Safety functions							
3.1		<b>Force monitoring (DES)</b>					
					0 = Off Adjustable for 2 % to 10 % overload		
3.2		<b>Interruption of the photo cell function (DES)</b>					
		Off					
		On (single reference position taught-in twice)					
3.3		<b>Travel time monitoring (NES)</b>					
				0 = Off 1 to 90 seconds			
3.4		<b>Door safety switch</b> (Input X2.2 / WSD door-module for "1", "2" and "4" only)					
		Slack-rope switch / Pass-door switch					
		Crash switch as NC contact After activation: "Hold-to-run" door operating mode					
		Crash switch as NO contact After activation: "Hold-to-run" door operating mode					
		Crash switch as NC contact After activation: Reversing in OPEN final limit position. Reset after contact reset otherwise "Hold-to-run" door operating mode					
		Crash switch as NO contact After activation: Reversing in OPEN final limit position. Reset after contact reset otherwise "Hold-to-run" door operating mode					
3.5		<b>Automatic opening</b> (Automatic closing menu item 2.3)					
				0 = Off 1 to 99 minutes			
3.8		<b>Reversing duration adjustment</b>					
				[ + ] slower [ - ] faster			











## DI/FI settings

4.1		<b>OPEN output speed</b>	
- + 00		Output speed in rpm	1x
4.2		<b>CLOSE output speed</b> When a safety device is triggered, the door moves at reduced speed.	
- + 00		Output speed in rpm	1x
4.3		<b>Increased CLOSE output speed</b> Up to an opening height of 2.5 m When a safety device is triggered, the door moves at reduced speed.	
- + 00		Output speed in rpm 0 = Off	1x
4.4		<b>Changeover position to CLOSE output speed</b> (with adherence to minimum opening height requirement of 2.5 m!)	
- -		Approach and store desired door position	1x
4.5		<b>OPEN acceleration</b>	
- + 00		DI Steps of 1.0 seconds FI Steps of 0.1 seconds	1x
4.6		<b>CLOSE acceleration</b>	
- + 00		DI Steps of 1.0 seconds FI Steps of 0.1 seconds	1x
4.7		<b>OPEN deceleration</b>	
- + 00		DI Steps of 1.0 seconds FI Steps of 0.1 seconds	1x
4.8		<b>CLOSE deceleration</b>	
- + 00		DI Steps of 1.0 seconds FI Steps of 0.1 seconds	1x
4.9		<b>OPEN/CLOSE crawling speed</b>	
- + 00		Output speed in rpm	1x

## Extended door functions

7.6	1x	<b>Selection of radio transmitters manufacturer</b> (434 MHz)				
	-	.	0	Internal radio receiver deactivated	1x	
	-	.	1	(Fixcode) GfA, Tedsen		
	-	.	2	Teleco "COD1"		
	-	.	3	-		
	-	.	4	(Rolling code of various providers) GfA UK, JCM, Dickert		
	-	.	5	(Fixed code) RDA		
	-	.	6	-		
	-	.	7	-		
	-	.	8	-		
	-	.	9	-		
	-	.	10	-		
7.7	1x	<b>Radio receiver function</b>				
	-	.	1	Teach-in of a handheld transmitter	1x	
	-	.	2	Cancellation of a taught-in handheld transmitter		
	-	.	3	Cancellation of all taught-in handheld transmitter		

### Maintenance cycle counter

8.5		<b>Maintenance cycle preselection</b>		0.0		
	0.0	0.1		9.9	01-99 corresponds to 1,000 to 99,000 cycles Cycles are counted down	
8.6		<b>Reaction upon reaching "0"</b>				
	.1	Status indication "CS" appears in turns with value set by menu item <b>8.5</b> .				
	.2	Changeover to "Hold-to-run" door operating mode. Status indication "CS" appears in turns with value set by menu item <b>8.5</b> .				
	.3	Changeover to "Hold-to-run" door operating mode. Status indication "CS" appears in turns with value set by menu item <b>8.5</b> . Option: Press STOP-button for 3 seconds to deactivate changeover and status indications for 500 cycles.				
	.4	Status indication "CS" appears in turns with value set by menu item <b>8.5</b> and relay contact X21 switches.				



## Readout of data memory

	 1x	<b>Cycle counter</b> 7-digit number	
	M	HT	ZT
	T	H	Z
	E		
	Displayed in division of ten consecutively <b>M</b> = 1,000,000 <b>ZT</b> = 10,000 <b>H</b> = 100 <b>E</b> = 1 <b>HT</b> = 100,000 <b>T</b> = 1,000 <b>Z</b> = 10		
	 1x	<b>Last faults</b>	
	Display change of the last 6 faults		
	 1x	<b>Data counter</b> 7-digit number	
	M	HT	ZT
	T	H	Z
	E		
	Displayed in division of ten consecutively <b>M</b> = 1,000,000 <b>ZT</b> = 10,000 <b>H</b> = 100 <b>E</b> = 1 <b>HT</b> = 100,000 <b>T</b> = 1,000 <b>Z</b> = 10		
	 1x	 1x	
	Cycle counter of the last change in programming		
	Number of activations of slack-rope, pass-door and crash switch		
	 1x	<b>Software version</b>	
	The software version of the control is displayed. For direct inverter or frequency inverter drive units, the software version of the motor is displayed as well.		

## Deleting / readout

	 1x	<b>Deleting of all settings</b>	
	 1x		Activating GfA stick
	 1x		All settings are set to factory setting! Except for cycle counter

## Reading out WSD door-module data



### WSD door-module data

(Only activated at taught-in WSD door-module,  
Displaying of missing data is done by „-.-.“)



Data indicated alternately

1. Version of master radio module
2. Type of safety edge
  - „0.0.“ = none
  - „0.1.“ = 1k2
  - „0.2.“ = 8k2
  - „0.3.“ = optic
  - „0.4.“ = WSD door-module with light curtain on X2
3. Door safety switch
  - „0.0.“ = inactive
  - „0.1.“ = active
4. Battery voltage
5. Assigned / selected communication channel
6. Signal quality ranging from 0% - 99%



Pay attention to the WSD door-module manual

## 9 Safety devices

### X2: Input, door safety switch

The door safety switch is installed on the door and connected to the door control via the spiral cable.

Menu item 3.4:

Function	Reaction upon activation
".1" Slack-rope switch / Pass-door switch	<ul style="list-style-type: none"> <li>• Switching contact is interrupted: Door stop</li> <li>• Switching contact is closed: Door is ready for operation</li> </ul>
".2" Crash switch as NC contact	<ul style="list-style-type: none"> <li>• Door stops</li> <li>• Changeover to "Hold-to-run" door operating mode</li> <li>• Frequency inverter: "Hold-to-run" door operating mode at crawling speed only</li> <li>• Fault reset only possible in OPEN final limit position: Press the STOP-button of the door control for 3 seconds</li> </ul>
".3" Crash switch as NO contact	Like function ".2"
".4" Crash switch as NC contact with reversing	<ul style="list-style-type: none"> <li>• Door stops + reversing</li> <li>• Fault reset only possible in OPEN final limit position: Takes place automatically as soon as the switching contact has closed</li> <li>• Switching contact continues to be interrupted: Changeover to "Hold-to-run" door operating mode</li> <li>• Frequency inverter: "Hold-to-run" door operating mode only at set-up speed</li> </ul>
".5" Crash switch as NO contact with reversing	Like function ".4"

## **Door safety switch**

The door safety switches (slack-rope switch / pass-door switch) are connected to a safety circuit with Performance Level c (Plc) according to ISO 13849-1 (X2.1/X2.2). Accordingly, only switches with the same Performance Level c (Plc) may be connected. The safety circuit requires an overall terminal resistance of 5k $\Omega$  for line cross-circuit monitoring. When the door safety switch is activated, it is not possible to move the door. When activated during door movement, an immediate STOP takes place. Fault indication F1.2 will be displayed.

## **Slack-rope switch**

The evaluation of the door control provides for the connection of two slack-rope switches. For line cross-circuit monitoring, a resistor of 1k $\Omega$  must be integrated in the switches. In the case of a line cross-circuit, fault indication F1.8 is displayed.

## **Electronic pass-door switch (Entrysense)**

The electronic pass-door switch (Entrysense) has a Performance Level c (Plc) according to ISO 13849-1 and is monitored by the door control. Any other switch used must have Performance Level c (Plc) according to ISO 13849-1.

For line cross-circuit monitoring, a resistor of 2k $\Omega$  must be integrated in the switch. In the case of switch failure, fault indication F1.7 is displayed. In the case of a line cross-circuit, fault indication F1.8 is displayed.

## **Crash switch as NC or NO contact**

The crash switch is activated if the door is pushed out of the mechanical guidance.

If the switching contact is activated, the door is stopped, fault indication F4.5 is displayed, and a changeover to "Hold-to-run" door operating mode is carried out. Movement of the door is only possible via the built in push button of the door control. "Hold to run" door operating mode for frequency inverter only at crawling speed.

The fault indication F4.5 can only be reset in OPEN final limit position by pressing the STOP-button of the door control for more than 3 seconds or by switching the mains voltage off and on. Fault indication F4.5 will recur, if the switching contact continues to be activated.

With the reversing function, a reset is carried out automatically in the OPEN final limit position as soon as the switching contact is closed. Otherwise only "Hold-to-run" door operating mode is possible.

## X2: Input for safety devices

The door control detects three different safety edges automatically. Alternatively, a light curtain can be connected.



### Important!

- Connect safety edge systems in accordance with EN 12978
- "Hold-to-run" door operating mode can always be used should the safety edge be defective

### Electrical safety edge

The input is meant for an electrical safety edge (NO) with a terminal resistance of 8k $\Omega$  (+/-5 % and 0,25 W).

If there is a short circuit, fault indication F2.4 is displayed.

If there is an open circuit, the F2.5 fault indication appears.

### Pneumatic safety edge

The input is meant for a pressure wave switch system (NC) with a terminal resistance of 1k $\Omega$  (+/-5 % and 0,25 W). Upon activation or permanent disconnection of the current circuit, the F2.6 fault indication appears.

If there is a short circuit, fault indication F2.7 is displayed.

The pressure wave switch system needs to be tested with CLOSE final limit position. The test phase is initiated automatically by the pre-limit for DES. If no switching signal is generated on the pressure wave switch within 2 seconds, the test is negative and the fault indication F2.8 is displayed.

### Optical safety edge system

The input is meant for an infrared safety beam sensor with transmitter and receiver in a rubber profile. By pressing the rubber profile, the light beam is interrupted.

The F2.9 fault indication appears upon activation or a faulty safety edge system.

## Light curtain

The light curtain detects people and obstacles without contact. If a light beam from the light curtain is interrupted, the door moves to final limit position OPEN. When the light beam is interrupted, fault indication F4.6 appears. When using a light curtain, menu item 0.3 must be set to function ".2" or ".3".

## Installation of the spiral cable

The spiral cable should enter the door control panel from the left- or right-hand side. The spiral cable should be fixed in place with a cable gland. The safety edge system is connected via the 3-pole plug, and the slack-rope or the pass door via the 2-pole plug.



### Important!

- ▶ Check position of S5 pre-limit switch on the safety edge (only for NES)
- When the door is opened > 5cm, a reversing must be executed if the safety edge has been activated

## Function: Safety edge function in the pre-limit area

Menu item 2.1:

Function	Reaction to activation of safety edge
".1" Active	<ul style="list-style-type: none"> <li>• Door stops</li> </ul>
".2" Inactive	<ul style="list-style-type: none"> <li>• No reaction</li> <li>• Door moves to CLOSE final limit position</li> </ul>
".3" Ground adjustment (DES)	<ul style="list-style-type: none"> <li>• Door stops; correction of the CLOSE final limit position at the next closing</li> </ul>
".4" Reversing in overrun area (DES)	<ul style="list-style-type: none"> <li>• Reversing upwards from the overrun area upon activation of the safety edge system</li> </ul>



**Note: Ground adjustment!**

- Automatic compensation of rope elongations or changes in ground conditions of approx. 2-5 cm
- With DES limit switch only
- Do not use with overrun correction
- Do not use with pressure-wave switch or light curtain.



**Note: Reversing upwards in the overrun area!**

- To maintain the operating forces in the pre-limit area
- At high speeds
- With DES limit switch only
- Function for FI-drive units not necessary

**Function: Overrun correction function (only DES)**

Menu item 2.2:

Automatic limit switch correction to achieve a constant CLOSE position.

Function	Overrun correction
".0"	Off
".1"	On



**Note: Overrun correction!**

- With DES limit switch only
- Do not use with ground adjustment

### Function: Reverse in case of obstacle

Menu item **2.5** extends menu item **2.3**:

Menu item **2.3** (automatic closing) allows the door to close automatically after a pre-set time has elapsed. If an obstacle is in the door movement path during the closing process (safety device is triggered), the door stops the closing attempt and then moves back to its starting position.

With menu item **2.5** (reversing in case of obstacle) you can set the number of closing attempts. For example, if the factory setting is ".2", the door will try to close twice and then stop in the upper start position if there is an obstacle. Fault indication F2.2 then appears in the menu.



#### Note!

- To reset fault F2.2: Move to CLOSE final limit position



## EMERGENCY operation



### Warning!

- ▶ For EMERGENCY operation, the door has to be checked (it has to be in a fault-free state)
  - “Hold-to-run” door operating mode:  
The door must be fully visible from the operating point

EMERGENCY operation allows for moving the door to a required position by bypassing faults with the signal transmission of the safety device.



EMERGENCY operation is activated after pressing the STOP push-button and holding for 7 seconds, and is indicated by the flashing display.



### Note!

- The door cannot be moved in case of F1.3 and F1.4 fault indications for reasons of operating safety.
  - ▶ Activation of EMERGENCY operation: Use the built in push button of the control to press and hold the STOP-button while simultaneously pressing the OPEN or CLOSE push-button to move the door

## X3: Input, emergency STOP

The emergency STOP control device is connected to a safety circuit with Performance Level c (Plc) according to ISO 13849-1. Connection of an emergency STOP control device as per EN 13850 or an evaluation unit for an anti-trap safety device. The F1.4 fault indication appears upon activation.



### Note!

- Frequency inverter drive unit: The emergency STOP switches the supply off. The door control can only be operated again 30 seconds after unlocking the emergency STOP. (Display rotates during this time)

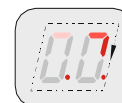

## 10 Functional description

### X: 24 VDC voltage supply

Connection of external devices such as photo cell, radio receiver, relay, etc. via the 24 V and GND terminals.



#### Attention – Damage to components!

- Total current consumption of external devices: maximum 350 mA

### X1: Mains supply of the control and supply of external devices

#### Mains supply of the control

Connection via the terminals X1/1.1 to X1/1.4 and PE.

Various mains supplies: 3 N~, 3~, 1 N~ for symmetric and asymmetric motors.



#### Note!

- ▶ Pay attention to the "Mains supply" and "Mains supply connection to control" descriptions

#### Supply of external devices

Connection of external devices for 230 V, such as photo cell, radio receiver, relay, etc. via terminals X1/1.8 and X1/1.9.



#### Note!

- The mains supply of external devices using terminals X1 / 1.8 and X1 / 1.9 is only possible if the door control is connected to supply networks with 3 N ~ 400 V or 1 N ~ 230 V (symmetrical)
- Protection via F1, 1.6-A time-lag micro-fuse

#### X4: Input, automatic closing Off/On

Connection of a switch via the terminals X4/1 and X4/2 for switching the automatic closing off and on.

#### X5: Input, control device



##### Warning!

▶ "Hold-to-run" door operating mode:

The door must be fully visible from the operating point

The door operating mode ".3" allows a place of installation of the control device without sight of the door.



##### Note!

- ▶ Application without STOP push-button: Connect wire link X5.1 to wire link X5.2
- If the safety edge or photo cell fails, the control device will not function

## X6: Input "Through / reflective photo cell" resp. light curtain

### Photo cell

A photo cell is used for presence detection. It is only active in door operating modes ".3" and ".4", in the OPEN final limit position or during the CLOSE-operation.

If the light beam is interrupted, fault indication F2.1 appears.

### Light curtain

The light curtain must be self-testing and correspond at least to safety category 2 or performance level c (plc). If the light curtain corresponds to these requirements, the door can close into self-hold without safety edge system.



#### Important!

- ▶ Operation without safety edge: Connect resistor 8k2 via the terminals X2/3 and X2/4
- ▶ Photo cells must not be used via the UBS system if a light curtain is used
- ▶ Do not use menu item 3.2 for the light curtain

- ▶ To test the light curtain, activate relay contact X20 or X21.

The relay functions are described under menu item 2.7 / 2.8.

If the light beam is interrupted, fault indication F4.6 appears.

With every CLOSE-command a test is run. Thereby the contact of the light curtain must switch off within 100 ms. If the test is positive, the contact must switch back on within 300 ms. If the test is negative, the fault indication F4.7 is displayed.

- ▶ To reset fault indication F4.7: Switch control off and on.



#### Note!

- ▶ Only use photo cells or light curtains with "Light switching" mode

## Reaction to interrupting of light beam

Door position	Reaction to interrupting of light beam
CLOSE final limit position	<ul style="list-style-type: none"> <li>No action</li> </ul>
OPEN-operation	<ul style="list-style-type: none"> <li>No action</li> </ul>
OPEN final limit position Without automatic closing	<ul style="list-style-type: none"> <li>No action</li> </ul>
OPEN final limit position With automatic closing	<ul style="list-style-type: none"> <li>Reset automatic closing</li> </ul>
OPEN final limit position With automatic closing and time interruption	<ul style="list-style-type: none"> <li>The door closes 3 seconds after the interruption period for the light beam has ended</li> </ul>

## Reaction of automatic closing to photo cell / light curtain

Menu item 2.4:

Function	Reaction of automatic closing to photo cell / light curtain
".0"	<ul style="list-style-type: none"> <li>No action</li> </ul>
".1" Stopping automatic closing	<ul style="list-style-type: none"> <li>The door closes 3 seconds after the interruption period for the light beam has ended</li> </ul>
".2" Vessel recognition	<ul style="list-style-type: none"> <li>The door closes after the interruption period for the light beam has ended, if the interruption period is longer than 1.5 seconds</li> <li>Reset of automatic closing if the interruption duration for the light beam is equal to or less than 1.5 seconds</li> </ul>

## Disconnection of photo cell function (only DES)

### Menu item 3.2

Function	Disconnection of photo cell function
".0"	Off
".1"	On

The teach-in mode gets activated after exiting the programming.



#### Warning!

- Presence detection is disabled in the teach-in mode

In the teach-in mode, the door must be fully opened and closed twice. The light beam must be interrupted twice at the same door position. The teach-in mode is then terminated. The photo cell has no function below this stored door position.

Teach-in mode display	
Upon exiting the programming	2.4
When the light beam is interrupted for the first time	1.4
After the second interruption to the light beam at the same door position, and with the CLOSE final limit position reached	L.4



#### Note!

- If the teaching in is not successful, open and close the door again, so that two identical door positions are stored

## X7: Input pull switch/radio receiver

Connection of a pull switch or external radio receiver via the terminals X7/1 and X7/2. The switching contact must be potential-free (NO contact).

### Pull switch or radio receiver function

Menu item 2.6:

Type of impuls	Reaction upon activation
".1"	<ul style="list-style-type: none"><li>• Door is in OPEN final limit position resp. intermediate open position: The door CLOSES</li><li>• From all other door positions or door movements: The door OPENS</li></ul>
".2"	<ul style="list-style-type: none"><li>• OPEN-STOP-CLOSE-STOP-OPEN command order</li></ul>
".3"	<ul style="list-style-type: none"><li>• Door always executes OPEN movement</li></ul>

## Internal radio receiver

The integrated radio receiver can be set for a specific radio transmitter manufacturer via menu item 7.6.

Handheld transmitters can be taught or deleted via menu item 7.7.



### Note!

- A combination of different radio transmitter manufacturers is possible
- Only use 434-MHz handheld transmitters
- Up to 64 radio channels can be taught

## Teach-in of handheld transmitters

### 1. Select radio transmitter manufacturer's system

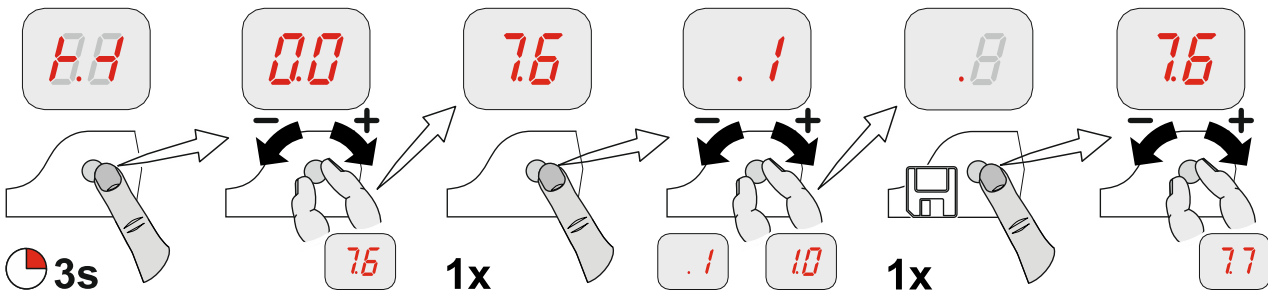

### 2. Activate radio transmitter

### 3. Carry out teaching-in

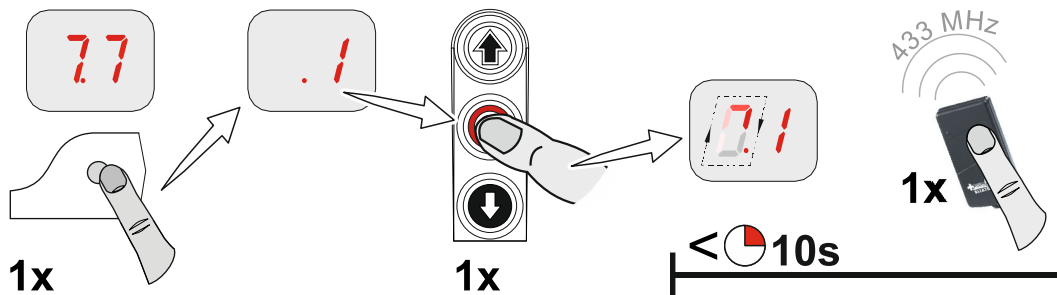

### 4. Switch to door operation

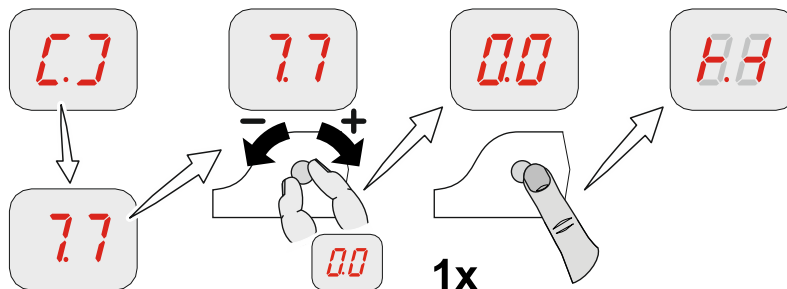



### Deleting an individual radio transmitter

1. Activate delete, 10 seconds active

2. Delete

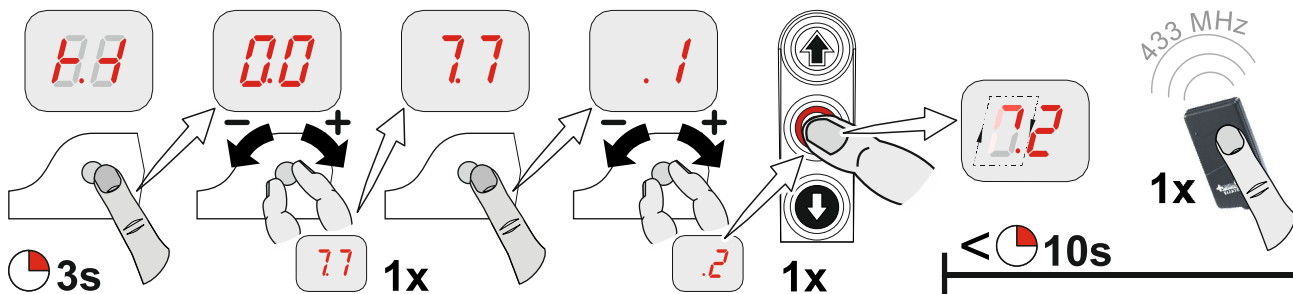

3. Switch to door operation

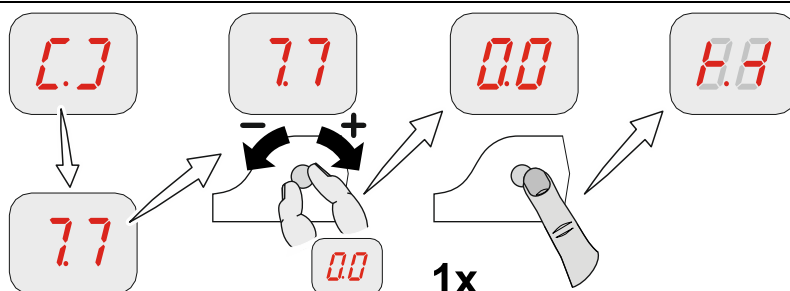

### Deleting all radio transmitters

1. Delete all channels

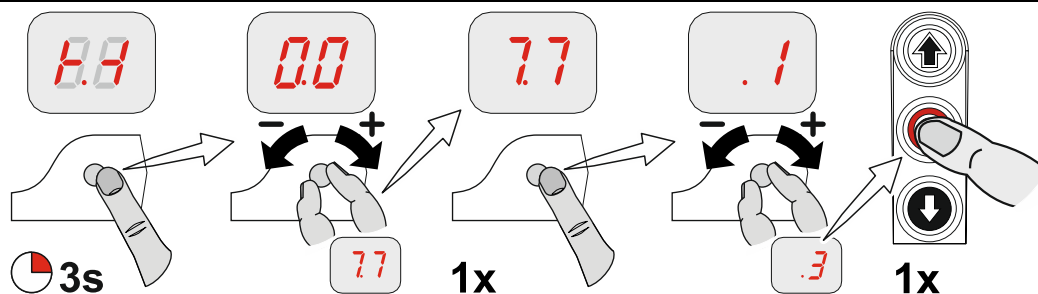

2. Switch to door operation

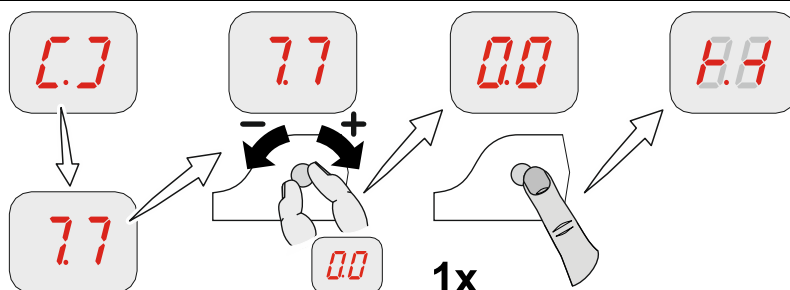

## X8: Input, intermediate stop On/Off

Connect a switch to terminals X8/1 and X8/2 to activate and deactivate the intermediate open. The intermediate open position muss be programmed via menu item 1.6.

With an OPEN command, the door moves to the stored door position. When the Intermediate open function is deactivated, the door can move back to the OPEN final limit position.

### Intermediate open function

Menu item 2.9:

Function	Intermediate open
".1"	<ul style="list-style-type: none"> <li>All command inputs</li> </ul>
".2"	<ul style="list-style-type: none"> <li>Intermediate open via X7 pull switch and internal radio receiver;</li> <li>OPEN final limit position via all other control devices</li> </ul>
".3"	<ul style="list-style-type: none"> <li>Intermediate open via external control devices X5 and OPEN push button of the control</li> <li>OPEN final limit position via all other control devices</li> </ul>



#### Note!

- Double command with functions ".2" and ".3": Priority is given to OPEN final limit position, independent of command sequence

## X20 / X21: Potential-free relay contacts

The relay functions are described under menu item 2.7 / 2.8.



### Attention – Damage to components!

- Maximum electrical current of 1 A at 230 V AC and 0.4 A at 24 V DC
- We recommend the use of LED lamps
- When using light bulbs, these should have power of maximum 40 W and be shock-proof

## Force monitoring (DES only)

Menu item 3.1:

The force monitoring can only be used with fully balanced doors and drive units with DES. It should be able to detect when persons are moving with the door.



### Warning!

- The force monitoring is no substitute for safety measures in providing protection against the trapping hazard

Function	Force monitoring
".0"	<ul style="list-style-type: none"> <li>• Off</li> </ul>
".2" - "1.0"	<ul style="list-style-type: none"> <li>• ".2": Low limit value</li> <li>• "1.0": High limit value</li> </ul>



### Important!

- Force monitoring for doors with spring balance only
- Environmental factors such as changes in temperature or wind load can lead to inadvertent triggering of force monitoring

After exiting programming, the door must carry out a full OPEN and CLOSE-operation in self-hold mode.

The force monitoring is a self-learning system which is effective for an opening gap of 5 cm to 2 m (approx.). Slow progressive changes, e.g. gradual reduction of the spring torsion, are compensated automatically.

After force monitoring has been triggered, only the "Hold-to-run" door operating mode is possible and the F4.1 fault indication is displayed. The resetting occurs when a final limit position for the door is reached.

### Travel time monitoring (NES only)

#### Menu item 3.3

The set travel time is automatically compared with the time measured for movement between the final limit positions. If the travel time is exceeded, the F5.6 fault indication appears.

Fault indication F5.6 is reset by closing the door.



#### Note!

- The travel time is set at the factory to 90 seconds
- Recommended setting value: door travel time + 7 seconds

## UBS system

The UBS system is a simple plug-in connection technology from GfA. The control devices are connected to the control by a commercially available patch cable and detected automatically.



### Note!

- The UBS devices function in the same way as wired control devices

### UBS connection

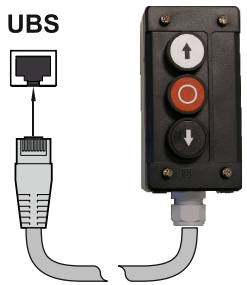
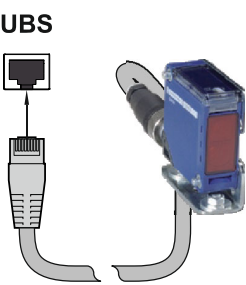
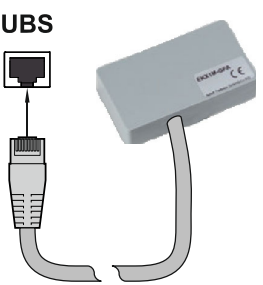
		
<p>Three push button</p>	<p>Reflective photo cell</p>	<p>External radio receiver</p>

## Reversing duration adjustment

Menu item 3.8:

Shortening the reversing duration serves for a reduction of the operating forces.

Extending it, on the other hand, will reduce the wear on the door mechanism.

## Maintenance cycle counter

Menu item **8.5**:

A value between 0 and 99,000, as a multiple of 1000, can be adjusted for the maintenance cycle setting. The maintenance cycle counter reading is reduced by one each time the Open final limit position is reached. Once the maintenance cycle reaches zero, the setting from menu item **8.6** is activated.

## Short-circuit/overload display

If there is a short circuit or an overload of the 24 VDC supply voltage, the 7-digit display vanishes.

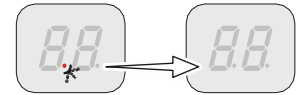

## Display for active WSD door-module wireless safety device

If the WSD door-module wireless safety device is active, an additional red point is displayed on the right-hand digit display.



## Standby function





If there is no fault or command pending, the control switches to Standby. If the automatic closing duration is longer than 60 seconds, the control also switches to Standby. Only the left dot is lit up. With active WSD door-module, both dots are lit up. The Standby function is terminated with a command or by activation of the selector switch **S**.



## Illumination of the built in push button of the door control











Only the command push-buttons which enable a next command are illuminated.

## 11 Status display











Faults		
	Display: "F" and code	
Code	Fault description	Fault causes and fault correction
	Terminals X2.1 – X2.2 are open. Slack-rope switch/Pass-door contact is open. The WSD door-module is not taught-in or the terminals X1/X2 in the WSD door module are open.	Check door safety switch. Check whether the connection cable is connected. Check the WSD door-module.
	Open safety circuit (DES) Emergency manual operation has been activated. Thermal protection of the motor has tripped	Check emergency manual operation. Check door and door drive unit for stalling. <b>Warning! Danger of the door dropping!</b> Stalling may indicate the anti fall back device (if incorporated) has activated. Take appropriate measures.
	Terminals X3.1 – X3.2 are open. Emergency STOP has been activated.	Check emergency STOP. Check whether the connection cable is connected.
	Radio transmission of WSD door-module is faulty.	<ul style="list-style-type: none"> <li>• Radio channel assigned twice: Use menu item 9.6 to read off the radio channel. Use menu item 2.0 to manually assign the radio channels.</li> <li>• Moisture in WSD door-module: Replace WSD door-module und use a splash guard (optional equipment).</li> <li>• Obstacle between WSD door-module and door control: Adapt fitting configuration or use a spiral cable.</li> <li>• Battery voltage too low: Read off voltage value using menu 9.6 and replace battery if this is less than 3.2 V.</li> </ul> <p>Red LED in WSD door-module: Press P1 push-button.</p> <ul style="list-style-type: none"> <li>• Flashing: Faulty radio connection</li> <li>• Lit: Radio connection OK</li> </ul>















Pay attention to the WSD door-module manual

<b>Faults</b>		
	<b>Display: "F" and code</b>	
<b>Code</b>	<b>Fault description</b>	<b>Fault causes and fault correction</b>
	Faulty entrysense switch. Faulty entrysense installation.	Open and close pass door. Check the DIP-switches in the junction box for spiral cable or WSD. Check the resistance and wiring of the spiral cable. Check the pass door installation.
	Line cross-circuit in the safety circuit.	Switch control off and on. Check the DIP-switches in the junction box for spiral cable or WSD. Check the resistance and wiring of the spiral cable.
	WSD door-module batteries are too low.	Change batteries of the WSD door-module. If the battery service life was considerably less than one year, check fault code 1.6 (radio channels assigned twice, obstacles).
	No safety edge detected.	Check the wiring of the safety edge. Check function of WSD door-module.
	Terminals X6.1 – X6.2 are open. Photo cell has been activated.	Check alignment of the photo cell. Check connection cable. Replace photo cell if necessary.
	Maximum number of reversing movements for door through safety edge system activation has been reached. (Only with automatic closing)	Obstacles along the door travel path. Check whether the safety edge system is correctly functioning.
	Activation of safety edge 8k2.	Check whether the safety edge system is correctly functioning. Check whether the connection cable has short-circuited.
	Safety edge 8k2 defective.	Check whether the safety edge system is correctly functioning. Check whether the connection cable is connected.
	Activation of safety edge 1k2.	Check whether the safety edge system is correctly functioning. Check whether the connection cable is connected.
	Safety edge 1k2 defective.	Check whether the safety edge system is correctly functioning. Check whether the connection cable has short-circuited.







<b>Faults</b>		
	<b>Display: "F" and code</b>	
<b>Code</b>	<b>Fault description</b>	<b>Fault causes and fault correction</b>
	1k2 testing is negative.	Testing is activated in the lower final limit position. Check pre-limit switch (with NES "S5").
	Wireless safety device of the WSD door-module or optical safety edge system has been activated or is defective.	Check the WSD door-module. Check whether the safety edge system is correctly functioning.
	(DES) OPEN emergency stop switch reached.	In the voltage-free state, move the door back via emergency manual operation.
	(NES) OPEN or CLOSE emergency stop switch reached. Emergency manual operation has been activated. Thermal protection of the motor has tripped Limit switch system has changed over from NES to DES without the control being reset.	Check OPEN/CLOSE emergency stop switch. Check emergency manual operation. Reset of control via menu item "9.5". Check door and door drive unit for stalling. <b>Warning! Danger of the door dropping!</b> Stalling may indicate the anti fall back device (if incorporated) has activated. Take appropriate measures.
	(DES) CLOSE emergency stop switch reached.	In the voltage-free state, move the door back via emergency manual operation.
	(NES) Faulty activation of the "S5" pre-limit switch.	Check the "S5" pre-limit switch for correct functioning and setting.
	No limit switch detected (active at initial operation).	Connect the limit switch to the control. Check the limit-switch connection cable.
	Limit switch system has changed over from DES to NES without the control being reset.	Reset of control via menu item "9.5".
	Internal plausibility error.	Execute fault clearance through movement command.
	Internal control temperature too high.	Switch off control and let it cool down.

<b>Faults</b>		
	<b>Display: "F" and code</b>	
Code	Fault description	Fault causes and fault correction
	Triggering of force monitoring.	Check the door mechanism for stiffness.
	Crash switch X2.1 – X2.2 is activated.	Check crash switch / connection cable. To reset fault: Press STOP-button and hold for 3 seconds.
	Light curtain actuated at terminals X2.3 - X2.5 / X6.1 - X6.2.	Check light curtain. Check whether the connection cable is connected.
	Light curtain defective.	Comply with the light curtain manufacturer's specifications. Check connection cable.
	Fault of the controller.	Switch control off and on. Replace control if necessary.
	ROM error.	Switch control off and on. Replace control if necessary.
	CPU error.	Switch control off and on. Replace control if necessary.
	RAM error.	Switch control off and on. Replace control if necessary.
	Internal fault of control.	Switch control off and on. Replace control if necessary.
	Fault of digital limit switch (DES)	Check DES connector and connection cable. Switch control off and on.
	Fault with door movement.	Check the limit switches for correct rotational movement. Switch control off and on. Check door and door drive unit for stalling. <b>Warning! Danger of the door dropping!</b> Stalling may indicate the anti fall back device (if incorporated) has activated. Take appropriate measures.





## Faults

Code	Fault description	Fault causes and fault correction
<b>F.</b>	<b>Display: "F" and code</b>	
<b>5.7</b>	Fault with rotating direction.	Change rotating direction via menu item "0.2".
<b>5.8</b>	Unacceptable door movement in stopped state.	Execute fault clearance trough movement command. Check brake and drive unit.
<b>5.9</b>	No compliance with specified travel direction at drive unit.	Execute fault clearance trough movement command. Check for overload of the drive.
<b>6.1</b>	DI / FI closing speed is too high.	Switch control off and on. Replace drive unit if necessary.
<b>6.2</b>	Internal FI communication fault.	Switch control off and on. Replace FI drive unit if necessary.
<b>6.3</b>	Low voltage in the DC voltage sink.	Execute fault clearance trough movement command. Check mains input voltage. Change slope durations/speeds.
<b>6.4</b>	Excess voltage in the DC voltage link.	Check mains input voltage. Execute fault clearance trough movement command. Change slope durations/speeds.
<b>6.5</b>	Temperature limit exceeded.	Check for overload of the drive unit. Cool down the drive unit and reduce the number of cycles.
<b>6.6</b>	Permanent current overload.	Check for overload of the drive unit. Check the door mechanism for stiffness or weight.
<b>6.7</b>	Brake / FI fault.	Check brake; replace if necessary. If problem recurs, replace drive unit.
<b>6.9</b>	Collective indication for FI.	Execute fault clearance trough movement command. Replace drive unit if message is continually displayed.
<b>8.1</b>	At initial operation minimum travel distance was not completed.	Move the door for at least 1 second.













### Commands

Commands	
	Display: "E" and code
Code	Command description
	An OPEN-command is present. Inputs X5.3, X7.2, internal radio system, UBS control device or UBS radio receiver
	A STOP-command is present. Inputs X5.2, X7.2, internal radio system, UBS control device or UBS radio receiver or simultaneous OPEN and CLOSE commands
	A CLOSE-command is present. Inputs X5.4, X7.2, internal radio system, UBS control device or UBS radio receiver













### Status indications









Status display	Description
	Preset value for maintenance cycle counter reached.
	Dot on left is not lit: control circuit has a short circuit or is overloaded.
	Dot on right is lit: internal WSD door-module is active.
	Function for changing the rotating direction is activated, only possible during initial operation.
	Change of rotating direction has been carried out, only possible during initial operation.

## Status indications

Status display	Description
 Flashing	Emergency operation is active or programming option is blocked.
 Flashing	Teach in OPEN final limit position.
 Flashing	Teach in CLOSE final limit position.
 Flashing	UPWARDS travel active.
 Flashing	CLOSING operation active.
	Stop between the set final limit positions.
	Stop at the OPEN final limit position.
	Stop at the intermediate stop position.
	Stop at the CLOSE final limit position.
	Teaching in or deleting of the WSD door-module or handheld transmitter is confirmed. Blocking of programming option confirmed. Flashing display: Unblocking of programming option active.
	Interruption of the photo cell function: At first interruption of the light beam.
	Interruption of the photo cell function: When exiting the programming.

## 12 Explanation of symbols

Symbol	Explanation
	Prompt: Read installation instructions
	Prompt: Check
	Prompt: Note
	Prompt: Note the setting of the menu below
	Factory setting of the menu
	Factory setting of the menu, value on the right
	Factory setting of the minimum limit, dependent on drive unit
	Factory setting of the maximum limit, dependent on drive unit
	Setting range
	Prompt: Select menu item or value, turn selector switch <b>S</b> to the left or to the right
	Prompt: View menu item, press selector switch <b>S</b> once
	Prompt: Store, press selector switch <b>S</b> once
	Prompt: Start programming, actuate the selector switch <b>S</b> for three seconds

Symbol	Explanation
	Prompt: Setting via OPEN/CLOSE built in push-button; Use OPEN push-button to increase value, CLOSE push-button to decrease value
 1x	Prompt: Press stop button once via built in push-button
 1x	Prompt: Save, press stop button once via built in push-button
 3s	Prompt: Save, press stop button for three seconds via built in push-button
 3s	Prompt: Reset the control, press stop button for three seconds via built in push-button
	Prompt: Move to door position
	Prompt: Move to door position for OPEN final limit position
	Prompt: Move to pre-limit
	Prompt: Move to door position for CLOSE final limit position

## Declaration of incorporation

within the meaning of Machinery Directive 2006/42/EC  
for partly completed machinery, Appendix II Part B



## Declaration of conformity

within the meaning of EMC Directive 2014/30/EU  
within the meaning of RoHS Directive 2011/65/EU  
within the meaning of RED Directive 2014/53/EU

GfA ELEKTROMATEN GmbH & Co. KG  
Wiesenstraße 81 · 40549 Düsseldorf  
Germany

We,  
**GfA ELEKTROMATEN GmbH & Co. KG**  
declare under our sole responsibility that the  
following product complies with the above  
directives and is only intended for installation in a  
door system.

Door control

### **TS 971**

Part no.: 20097100

We undertake to transmit in response to a  
reasoned request by the appropriate regulatory  
authorities the special documents on the partly  
completed machinery.

This product must only be put into operation  
when it has been determined that the complete  
machine/system in which it has been installed  
complies with the provisions of the above-  
mentioned directives.

Authorised representative to compile the  
technical documents is the undersigned.

Düsseldorf, 21.10.2019

**Stephan Kleine**  
CEO

Signature

The following requirements from Appendix I of  
the Machinery Directive 2006/42/EC are met:  
1.1.2, 1.1.3, 1.1.5, 1.2.1, 1.2.2, 1.2.3, 1.2.4.2,  
1.2.5, 1.2.6, 1.3.1, 1.3.2, 1.3.3, 1.3.4, 1.3.9,  
1.5.1, 1.5.2, 1.5.4, 1.5.5, 1.5.6, 1.5.7, 1.5.8,  
1.5.9, 1.5.10, 1.5.11, 1.5.13, 1.6.1, 1.6.2, 1.6.4,  
1.7.1.1, 1.7.1.2, 1.7.2, 1.7.3, 1.7.4.3.

Standards applied:

### **EN 300328-2:2017**

Wideband transmission systems - Data  
transmission equipment operating in the 2,4 GHz  
ISM band and using wide band modulation  
techniques

### **EN 12453:2019**

Industrial, commercial and garage doors and  
gates - Safety in use of power operated doors -  
Requirements

### **EN 12978:2003+A1:2009**

Industrial, commercial and garage doors and  
gates - Safety devices for power operated doors  
and gates - Requirements and test methods

### **EN 60335-2-103:2015**

Household and similar electrical appliances -  
Safety - Part 2-103: Particular requirements for  
drives for gates, doors and windows

### **EN 61000-6-2:2005**

Electromagnetic compatibility (EMC) Part 6-2  
Generic standards – Immunity standard for  
industrial environments

### **EN 61000-6-3:2007**

Electromagnetic compatibility (EMC) Part 6-3  
Generic standards – Emission standard for  
residential, commercial and light-industrial  
environments